

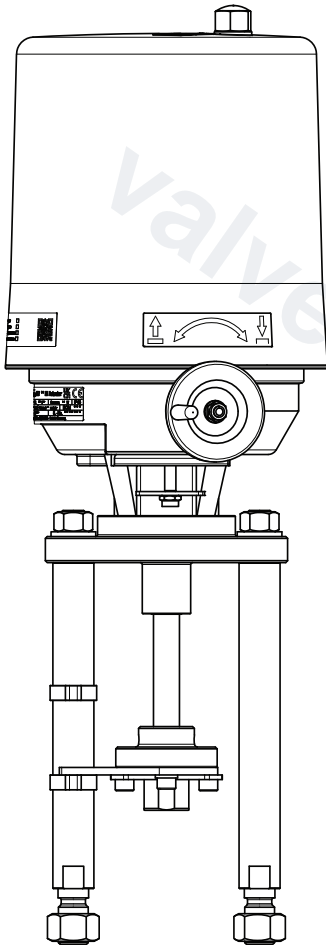
## AEL7 Series

### Electric Linear Actuators

Installation and Maintenance Instructions

---

---



1. Safety information
2. General product information
3. Installation
4. Electrical connection
5. Actuator accessories
6. Commissioning
7. Maintenance
8. Declaration of Conformity

# Contents

<b>1. Safety information</b>	<b>5</b>
1.1 Wiring notes	
1.2 Safety requirements and electromagnetic compatibility	
1.3 Intended use	
1.4 Access	<b>6</b>
1.5 Lighting	
1.6 Hazardous liquids or gases in the pipeline	
1.7 Hazardous environment around the product	
1.8 The system	
1.9 Pressure systems	<b>7</b>
1.10 Responsibilities of the operator and operating (including maintenance) personnel	
1.11 Temperature	
1.12 Tools and consumables	
1.13 Protective clothing	
1.14 Permits to work	
1.15 Handling	
1.16 Safe lifting practice	<b>8</b>
1.17 Residual hazards	
1.18 Disposal	
1.19 Returning products	
<b>2. General product information</b>	<b>9</b>
2.1 Introduction	
2.2 Series in the AEL7 range	<b>10</b>
2.3 Operating principle	<b>11</b>

<b>3. Installation</b>	<b>12</b>
3.1 Location	
3.2 Operational Considerations – End Position and Stroke Settings	<b>13</b>
3.3 Operational Considerations – Motor Brake	
3.4 Hand wheel Assembly (6 – 20 kN)	<b>14</b>
3.5 Coupling the Actuator to a Valve	
<b>4. Electrical connections</b>	<b>18</b>
4.1 Electrical Connection Safety Information	
4.2 Removing the Actuator Cover	
4.3 Making the Electrical Connection	<b>21</b>
4.4 Electrical Connection	<b>22</b>
<b>5. Actuator Accessories</b>	<b>26</b>
5.1 Actuator Accessory Safety Information	
5.2 Auxiliary Travel Switches	<b>28</b>
5.3 Potentiometer	<b>32</b>
5.4 Anti-Condensation Heater	<b>36</b>
5.5 Positioner Card	<b>42</b>
<b>6. Commissioning</b>	<b>45</b>
6.1 Commissioning Safety Information	
6.2 Adjustment of Travel Dependent Switch S3 (8-20 kN actuators only)	<b>46</b>
6.3 Adjustment of Auxiliary Travel Switch	<b>47</b>
6.4 Auxiliary Position Switch – Actuators with Shutdown Module	<b>48</b>
6.5 Commissioning of Positioner Card	<b>49</b>
6.6 Vac Positioner Electronics Card (Excl. Shutdown Module Versions)	<b>50</b>
6.7 AUTOTUNE – Quick Set-Up (Vac Excl. Shutdown Module Versions)	<b>52</b>
6.8 AUTOTUNE – Setting the Stroke with Positioner (Vac Excl. Shutdown Module Versions)	<b>53</b>
6.9 Vdc Positioner Electronics Card (Incl. Shutdown Module Versions)	<b>54</b>
6.10 AUTOTUNE – Quick Set-Up (24Vdc excl. Shutdown Module versions)	
6.11 AUTOTUNE – Quick Set-Up (All Shutdown Module versions)	<b>57</b>
6.12 Adjustment of Actuator Stroke (8 kN+)	<b>58</b>

---

<b>7. Maintenance</b>	<b>60</b>
7.1 Maintenance Safety Information	
7.2 General Maintenance of Actuator	
7.3 Warranty, Repair and Spare Parts	<b>61</b>
7.4 Shutdown Module Discharge	<b>62</b>
7.5 Removing the Actuator from the Valve	<b>64</b>
7.6 Problem Solving	<b>65</b>
<b>8. Declaration of Conformity</b>	<b>66</b>

---

valvesgo.com

Copyright © Spirax-Sarco Limited 2024

**All rights reserved**

Spirax-Sarco Limited grants the legal user of this product (or device) the right to use the Work(s) solely within the scope of the legitimate operation of the product (or device). No other right is granted under this licence. In particular and without prejudice to the generality of the foregoing, the Work(s) may not be used, sold, licensed, transferred, copied or reproduced in whole or in part or in any manner or form other than as expressly granted here without the prior written consent of Spirax-Sarco Limited.

# 1. Safety information

Safe operation of this product can only be guaranteed if it is properly installed, commissioned, used and maintained by qualified personnel (see Section 1.13) in compliance with the operating instructions. General installation and safety instructions for pipeline and plant construction, as well as the proper use of tools and safety equipment must also be complied with.

See separate Installation and Maintenance Instructions for the control valve.

If the actuator is handled improperly or not used as specified, the resultant may:



- Cause danger of the life and limb of the third party
- Damage the actuator and other assets belonging to the owner
- Hinder the performance of the actuator

## 1.1 Wiring notes

Every effort has been made during the design of the actuator to ensure the safety of the user, but the following precautions must be followed:

- i) Maintenance personnel must be suitably qualified in working with equipment containing hazardous live voltages.
- ii) Ensure correct installation. Safety may be compromised if the installation of the product is not carried out as specified in this manual.
- iii) Isolate the actuator from the mains supply before opening the unit.
- iv) The actuator is designed as an installation category II product, and is reliant on the building installation for overcurrent protection and primary isolation.
- v) Wiring should be carried out in accordance with IEC 60364 or equivalent.
- vi) Fuses should not be fitted in the protective earth conductor. The integrity of the installation protective earth system must not be compromised by the disconnection or removal of other equipment.
- vii) A disconnecting device (switch or circuit breaker) must be included in the building installation.

This must be in close proximity to the equipment and within easy reach of the operator.

- There must be a 3 mm contact separation in all poles.
  - It must be marked as the disconnecting device for the actuator.
  - It must not interrupt the protective earth conductor.
  - It must not be incorporated into a mains supply cord.
  - The requirements for the disconnecting device are specified in IEC 60947-1 and IEC 60947-3 or equivalent.
- viii) The actuator must not be located in such a way that the disconnecting device is made difficult to operate.

## 1.2 Safety requirements and electromagnetic compatibility

This product is  marked.

It complies with the requirements of 73/23/EEC as amended by 93/68/EEC on the harmonisation of the law of Member States relating to electrical equipment designed for use within certain voltage limits (LVD), by meeting the standard for safety of electrical equipment for measurement control and laboratory use. This product complies with the requirement of 89/336/EEC as amended by 92/31/EEC and 93/68/EEC on the approximation of laws of the Member States relating to Electromagnetic Compatibility, by meeting the generic standard of emissions for an industrial environment and the generic standard of immunity for an industrial environment. The product may be exposed to interference above the limits of industrial immunity if:

- i) The product or its wiring is located near to a radio transmitter.
- ii) Excessive electrical noise occurs on the mains supply.
- iii) Cellular telephones and mobile radios may cause interference if used within approximately one metre of the product or its wiring. The actual separation necessary will vary according to the power of the transmitter.
- iv) Power line protectors (ac) should be installed if mains supply noise is likely.
- v) Protectors can combine filtering, suppression, surge and spike arrestors.

For a copy of the Declaration of Conformity please refer to page 66.

## 1.3 Intended use

The AEL7 Series actuator must only be used to modulate Spirax Sarco and Gestra valves (including Hiter). The actuator must not be used for any other purpose.

Referring to the Installation and Maintenance Instructions, name-plate and Technical Information Sheet, check that the product is suitable for the intended use/application.

- i) Check products suitability to ensure product is suitable in relation to the thrust required to modulate and close the valve. (Refer to TI-P713-02)
- ii) Check that actuator is suitable for the operating environment and insure adequate protection is implemented when required
- iii) Determine the correct installation situation.
- iv) Spirax Sarco products are not intended to withstand external stresses that may be induced by any system to which they are fitted. It is the responsibility of the installer to consider these stresses and take adequate precautions to minimise them.

## 1.4 Access

Ensure safe access and if necessary a safe working platform (suitably guarded) before attempting to work on the product. Arrange suitable lifting gear if required.

## 1.5 Lighting

Ensure adequate lighting, particularly where detailed or intricate work is required.

## 1.6 Hazardous liquids or gases in the pipeline

Consider what is in the pipeline or what may have been in the pipeline at some previous time. Consider: flammable materials, substances hazardous to health, extremes of temperature.

## 1.7 Hazardous environment around the product

Consider: explosion risk areas, lack of oxygen (e.g. tanks, pits), dangerous gases, extremes of temperature, hot surfaces, fire hazard (e.g. during welding), excessive noise, moving machinery.

## 1.8 The system

Consider the effect on the complete system of the work proposed. Will any proposed action (e.g. closing isolation valves, electrical isolation) put any other part of the system or any personnel at risk? Dangers might include isolation of vents or protective devices or the rendering ineffective of controls or alarms. Ensure isolation valves are turned on and off in a gradual way to avoid system shocks.

## 1.9 Pressure systems

Ensure that any pressure is isolated and safely vented to atmospheric pressure. Consider double isolation (double block and bleed) and the locking or labelling of closed valves. Do not assume that the system has depressurised even when the pressure gauge indicates zero.

## 1.10 Responsibilities of the operator and operating (including maintenance) personnel

The operator is responsible for ensuring that safe systems of operation and practice are implemented and maintained. Only competent persons must be allowed to be able to operate and maintain these devices, and these persons must be familiar with, and comply with the applicable health and safety standards or guidelines.

The installation and maintenance instructions should form part of the standard operating procedures for maintenance and must therefore be kept in an accessible location and in a legible condition.

Product identification and safety related labels must also be kept in a clean and legible condition. Identification and safety labels must be replaced if they become damaged or obscured in operation.

## 1.11 Temperature

Allow time for temperature to normalise after isolation to avoid danger of burns.

The actuator must not be insulated. When coupled to a valve operating on high temperature media, if there is a risk of burning through handling (intentional or accidental), it is recommended that suitable methods of prevention are implemented e.g. machine or a visual warning.

## 1.12 Tools and consumables

Before starting work ensure that you have suitable tools and/or consumables available. Use only genuine Spirax Sarco replacement parts.

## 1.13 Protective clothing

Consider whether you and/or others in the vicinity require any protective clothing to protect against the hazards of, for example, chemicals, high/low temperature, radiation, noise, falling objects, and dangers to eyes and face.

## 1.14 Permits to work

All work must be carried out or be supervised by a suitably competent person. Installation and operating personnel should be trained in the correct use of the product according to the Installation and Maintenance Instructions. Where a formal 'permit to work' system is in force it must be complied with. Where there is no such system, it is recommended that a responsible person should know what work is going on and, where necessary, arrange to have an assistant whose primary responsibility is safety. Post 'warning notices' if necessary.

## 1.15 Handling

Manual handling of large and/or heavy products may present a risk of injury. Lifting, pushing, pulling, carrying or supporting a load by bodily force can cause injury particularly to the back. You are advised to assess the risks taking into account the task, the individual, the load and the working environment and use the appropriate handling method depending on the circumstances of the work being done.

## 1.16 Safe lifting practice

Never use the actuator to lift a valve. It is recommended to lift the complete valve assembly using the correct equipment(s) and techniques so as not to cause damage or injury. Valves should be supported under the inlet and outlet connections, not the actuator (including hand wheel or accessories), and careful attention should be made to prevent the valve from rotating during the lift sequence. When installed, neither the actuator, valve or its accessories should be used as a hand hold or step for access to other parts of the plant.

## 1.17 Residual hazards

In normal use the external surface of the product may be very hot. If used at the maximum permitted operating conditions the surface temperature of some products may exceed temperatures of 90 °C (194 °F).

## 1.18 Disposal

Unless otherwise stated in the Installation and Maintenance Instructions, this product is recyclable and no ecological hazard is anticipated with its disposal providing due care is taken.

### Regulation (EC) No 1907/2006 -

### Registration, Evaluation, Authorisation and Restriction of Chemicals (REACH)

Should any substances of very high concern be found within a product, details of the location will be identified within installation and maintenance instructions Section 2.4 : Materials.

Further information about product compliance is available at [www.spiraxsarco.com/product-compliance](http://www.spiraxsarco.com/product-compliance)

## 1.19 Returning products

Customers and stockists are reminded that under EC Health, Safety and Environment Law, when returning products to Spirax Sarco they must provide information on any hazards and the precautions to be taken due to contamination residues or mechanical damage which may present a health, safety or environmental risk. This information must be provided in writing including Health and Safety data sheets relating to any substances identified as hazardous or potentially hazardous.

## 2. General product information

### 2.1 Introduction

AEL7 series electric linear actuators are only suitable for the use on Spirax Sarco, Gestra and Hiter Valves. Refer to TI-P713-02 for product compatibility and linkage requirements. The AEL7 Series actuators must not be used for any other purpose. Actuators will normally be supplied fitted to the control valve. When supplied separately, ensure the actuator selected is capable of providing the force necessary to close the two-port or three-port control valve against the expected differential pressure. See the appropriate product specific Technical Information Sheet for full details of the control valve.

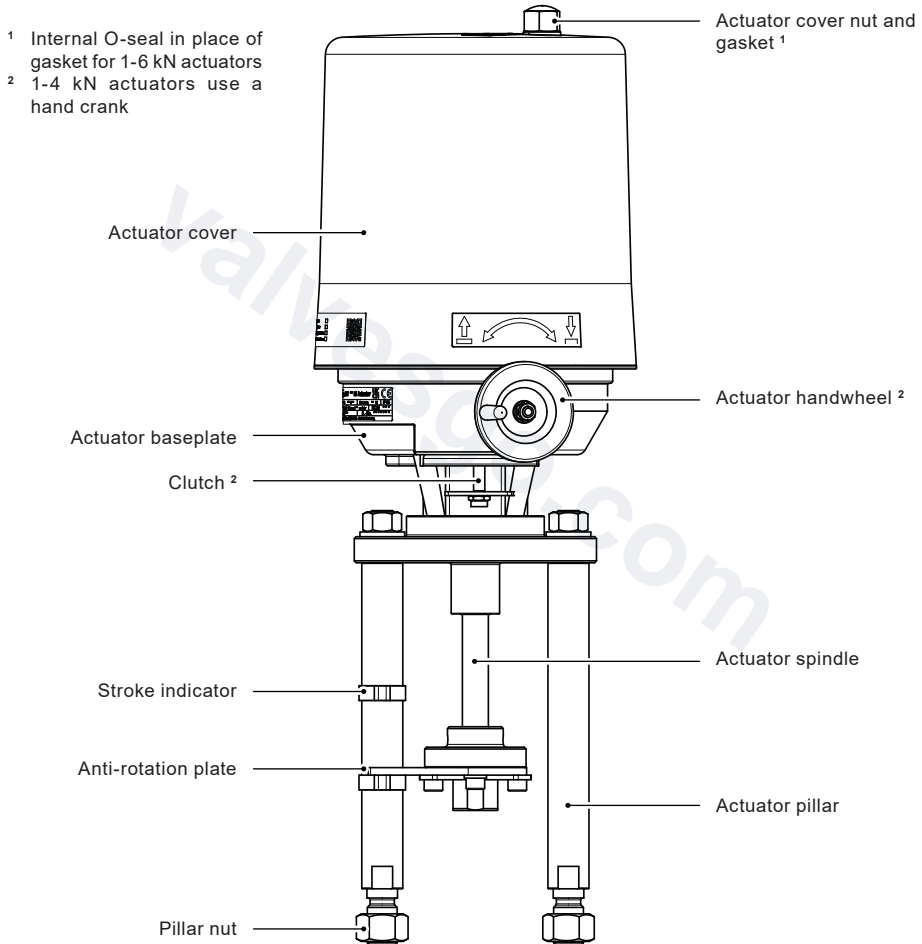


Fig. 1 AEL7 General arrangement

## 2.2 Series in the AEL7 range

Table 1 AEL7 Series Nomenclature

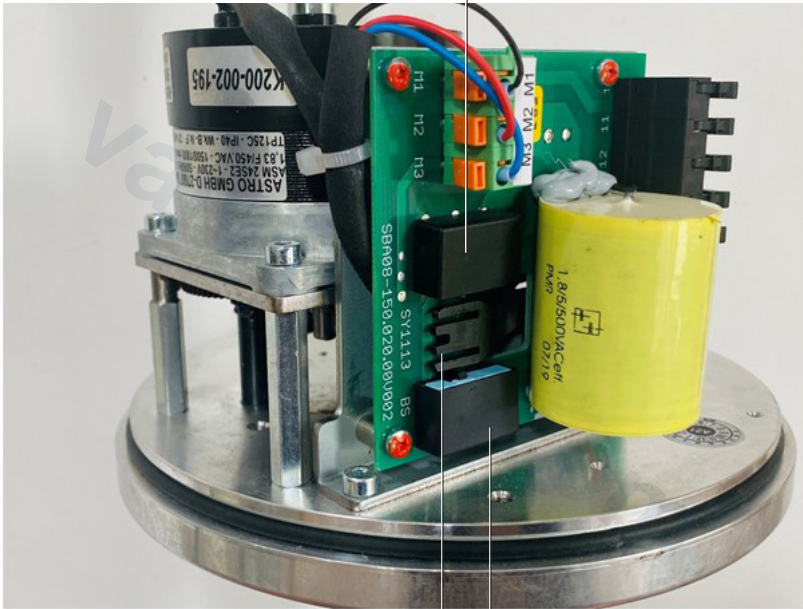
<b>Actuator</b>	A	-	
<b>Type</b>	E	Electric	
<b>Action</b>	L	Linear	
<b>Series</b>	7	-	
<b>Thrust</b>	1	1.2 kN	0.9 kN for AEL71T
	2	2.0 kN	2.1 kN for AEL72T
	3	4.0 kN	
	4	6.0 kN	
	5	8.0 kN	
	6	12.0 kN	
	7	15.0 kN	
	8	20.0 kN	
<b>Nominal Stroke</b>	1	20 mm	Stroke Setting from factory. For full stroke information and adjustment, refer to IM-P713-01.
	2	30 mm	
	3	50 mm	
	4	70 mm	
<b>Speed</b>	1	Low	<0.7 mm/s (Refer to TI-P713-02)
	2	Medium	0.8-1.5 mm/s
	3	High	1.6+ mm/s
<b>Supply Voltage</b>	1	230 Vac	
	2	115 Vac	
	3	24 Vac	
	4	24 Vdc	
<b>Control Signal</b>	F	VMD	24 Vac
	G	VMD	110 Vac
	J	VMD	230 Vac
	K	VMD	24 Vdc
	P	Modulating	(0)4-20mA / 0(2)-10V Positioner
<b>Failure Mode</b>	X	None	
	S	Super-Capacitor	Non-retrofit option. Not suitable for 24 Vac
	T	Spring	Non-retrofit option. Not suitable for 24Vdc
<b>Potentiometer</b>	X	None	
	A	Potentiometer	1 x 1000Ω

## 2.3 Operating principle

The AEL7 Series is a range of linear electric actuators of various voltages and thrusts suitable for the modulation of Spirax Sarco Group valves either by means of VMD or modulating signal. Independent of the control method, the actuators typically uses two physical force dependent (torque) switches to determine the end position of the actuator stroke in both directions and stop the actuator motor i.e. uses the end stops within the valve in order to determine stroke. The force dependent switches do not require any adjustment to correspond to valves with different lengths of stroke.

The potentiometer and positioner card (when fitted) are set to a predetermined stroke at the factory. This can be adjusted locally in order to suit the respective valve and provide optimum position control or feedback.

Torque Switch (DE) – Actuator Extend



Torque Switch Cam

Torque Switch (DE) – Actuator Retract

Fig. 2

# 3. Installation

Before considering installation of an AEL7 Series actuator please read to Section 1 "Safety Information" on page 5.



- **Installation awareness**

- Lifting and fitting of actuators increases the risk of personal injury
- Mains connection and commissioning of the AEL7 Series actuator requires specialist knowledge of electrical circuits and systems, and the inherent dangers. A working knowledge of linear actuators is also required.
- Risk of injury by moving parts. Ensure that the control system is disabled and the electrical power supply is isolated to ensure that the valve and actuator do not move without warning.
- The incorrect use of power supplies to assist the installation, commissioning and maintenance of electrically actuated valve assemblies increases the risk of personal injury.
- Lifting and fitting of actuators increases the risk of personal injury

- **Crush hazard**

When actuators are to be fitted using lifting equipment **always** ensure that the actuator is carefully slung in order that it cannot fall. **Never** attempt to remove a control valve from the line by using the actuator as the lifting point. The actuator or the lifting equipment could become damaged.

Never stand under components that are being lifted. Head safety protection must always be worn when operating on or close to equipment where lifting operations are taking place.

**Do not** place hands within the actuator yoke or on the stem when isolation of the electrical power supply has been removed.

**Do not** attempt to restrict actuator stroke or movement, or increase seat load through the placing of objects within the actuator yoke. This practice could also result in the **loss of sight**.

- **Warning**

**Muscular skeletal damage**

For small actuators that do not require mechanical lifting aids, always ensure that manual lifting best practice is observed. Always use two personnel where possible and ensure that proper access is available in order to ensure a secure foothold.

### 3.1 Location

The actuator should be mounted above the valve and provide sufficient space to remove the cover and provide general ease of access. When selecting the location, make sure that the actuator is not exposed to an ambient temperature exceeding the range -20 °C to + 60 °C (-20 °C to +50 °C for actuators fitted with positioners). All actuators except AEL71 is IP54, but only when the lid is correctly fitted (see Section 3.3). Adequate shelter and an anti-condensation heater must be provided for outdoor installations. For internal installations where there is a risk of condensation an anti-condensation heater should also be installed. Refer to Technical Information Sheets for details.(TI-P713-02)

The AEL7 Series actuator motor is protected by a thermal cut-out switch within the (Vac) motor. This is set to consider the maximum ambient temperature allowance of 60 °C for the motor. The motor will not operate once the thermal threshold has been breached until the temperature within the actuator has reduced by 20 °C.

For the 24 Vdc actuators, the motor will remain operational until the duty cycle of the motor is exceeded, or internal critical temperature has been reached, at which point motor operation will cease. The motor can be permanently damaged at this point. Therefore, it is important that the location of all AEL7 Series actuators considers the ambient temperature limits stated above.

Temperature recording strips are included in the actuator to help identify if a critical operating temperature has been reached.

### 3.2 Operational Considerations – End Position and Stroke Settings

The AEL7 Series actuator typically uses two physical force dependent (torque) switches to determine the end position of the actuator stroke in both directions i.e. it uses the end stops within the valve in order to determine stroke.

The force dependent switches do not require any adjustment to correspond to valves with different lengths of stroke.

The potentiometer and positioner card (when fitted) are set to a predetermined stroke at the factory. This can be adjusted locally (Sections 5.3 and 5.5) in order to suit the respective valve and provide optimum position control or feedback.

For the 8-20 kN versions only, valve stroke can be reduced with an internally configured travel dependent switch (S3). This is used to prevent potential damage to the valve plug and stem in the case when maximum material strength is exceeded.

Stroke settings for new actuators are identified in Table 2. Optional auxiliary switches, when fitted, do not impact actuator stroke. Adjustment of the S3 cams can be found in Section 6.2.

**Table 2 Actuator Stroke Settings**

Actuator	Thrust ( kN)	Maximum stroke	Set Stroke (mm) Positioner or Potentiometer	Set Stroke (mm) Travel Dependent Switch S3
AEL71 - - - - -	1	20	20	- n/a -
AEL72 - - - - -	2	40	30	- n/a -
AEL73 - - - - -	4	40	30	- n/a -
AEL74 - - - - -	6	50	30	- n/a -
AEL75 - - - - -	8	60	30	30
AEL76 - - - - -	12	60	30	30
AEL77 - - - - -	15	60	30	30
AEL78 - - - - -	20	100	70	70

### 3.3 Operational Considerations – Motor Brake

The motor of the AEL7 Series actuator typically slows and stops under its own momentum when the control power is removed. For the 20 kN version only (AEL78), an electronic brake is used on the motor in order to reduce inertial overrun and positioning inaccuracy, therefore reducing the wear on the actuator components.

### 3.4 Hand wheel Assembly (6 – 20 kN)

The 6 – 20 kN versions of AEL7 have an externally mounted hand wheel with operating clutch for manual adjustment of the actuator when the electrical power supply and control signals are isolated.

The hand wheel is shipped inside the actuator. In order to assemble the hand wheel to the actuator:

- Remove the actuator cover (Section 4.2)
- Cut the retaining tie taking care not to damage any of the internal wiring
- Carefully dispose of the tie
- Remove the lock nut from the actuator base plate and carefully slide the hand wheel over the hand wheel shaft, taking care to align the drive pin or key
- Replace and tighten the lock nut



#### Caution

Always take note of the operating direction of the hand wheel or hand crank in relation to the required direction of spindle movement. Failure to observe the correct direction of operation could result in damage to actuator or process.

### 3.5 Coupling the Actuator to a Valve

The operator is responsible for ensuring that safe systems of operation and practice are implemented and maintained. Only competent persons must be allowed to be couple the AEL7 Series actuator to a valve, and these persons must be familiar with, and comply with the applicable health and safety standards or guidelines.



#### Caution

It is possible to damage the force dependent switches by applying excessive load by use of the hand wheel or hand crank

- Some valve and actuator combinations will require additional valve adapters and linkage kits.
- Consult TI-P713-02 ensure you have the correct valve and actuator for your application.
- Remove the actuator retaining nut from the valve and place the mounting flange over the valve bonnet thread.
- Refit the actuator retaining nut and tighten (50 Nm for M34 or 100 Nm for M50).
- Remove the actuator pillar nuts. Using the hand wheel or hand crank, retract the actuator spindle by approximately 25% of valve stroke to ensure that the valve is coupled with the plug away from the seat in order to prevent valve damage.
- Untighten the four screws and remove the valve adapter locking plate, anti-rotation plate and valve adapter bush from the actuator.
- Place the locking plate and the anti-rotation plate over the valve stem.
- Set the valve stem lock nut at the correct Thread Engagement dimension "A" (Figure 4 and Tables 3 – 5) for the relevant valve and actuator combination.
- Lift the actuator over the valve stem and place onto the mounting flange and loosely refit the actuator pillar nuts raise the valve plug to the actuator until the threaded bush meets the actuator coupling.



Before the pillar nuts are tightened, make sure that the pillar ends are completely inserted into the bores of the valve mounting flange. If necessary, correct the position of the actuator using the handwheel or hand crank.

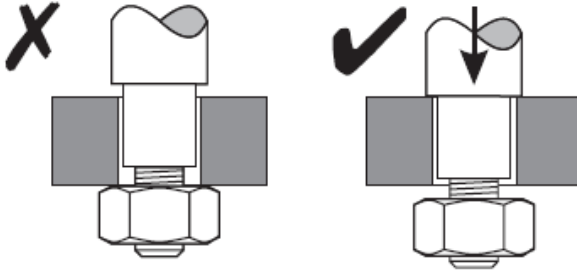


Fig. 3

Using the handwheel, lower the actuator stem until it touches the valve adaptor.

With the valve adaptor and actuator spindle aligned correctly and with the plug off the valve seat :

- Couple the anti-rotation plate
- Couple the adapter locking plate
- Tighten the pillar nuts to 30 Nm
- Tighten the 4 valve adaptor screws to 8 Nm
- Tighten the thread lock nut to 15 Nm

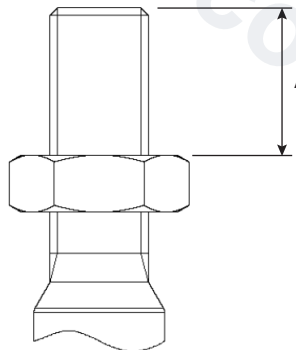


Fig. 4 Thread Engagement

**Table 3 Thread Engagement – Spira-trol™ 2-port**

Actuator Thrust	Spira-trol™ J, K & L 2-Port Valves		
	DN15-50	DN65-100	DN125+
1.2 kN	12 mm <sup>1</sup>	n/a	n/a
2.0 kN		19 mm <sup>2</sup>	
4.0 kN			
6.0 kN			
8.0 kN			
12.0 kN			
15.0 kN	n/a	19 mm <sup>3</sup>	30 mm
20.0 kN			

<sup>1</sup> DN15-50 J Series Requires AEL7XJ01 extended adapter

<sup>2</sup> DN65-100 J Series Requires AEL7XJ02 extended adapter

<sup>3</sup> Requires AEL7XM12 M12 adapter

**Table 4 Thread Engagement – 3-port**

Actuator Thrust	3-Port Valves		
	DN15-50	DN65-100	DN125+
1.2 kN	12 mm	n/a	n/a
2.0 kN		14 mm	
4.0 kN			
6.0 kN			
8.0 kN			
12.0 kN			
15.0 kN	n/a	18 mm	27 mm <sup>2</sup>
20.0 kN		18 mm <sup>1</sup>	

<sup>1</sup> Requires AEL7XM12 adapter

<sup>2</sup> Requires AEL7XQ18 adapter

**Table 5 Thread Engagement and Yoke Kit – Hiter S85 / S1000 2-port**

Valve Model	Ø (")	Thread Engagement (mm)
08-18-58-68-02-12-52-62	0.5	26
	0.75	25
	1.0	25
	1.5	14
01-11-51-61-21-71 Full Bore	1	32
	1.5	18
01-11-51-61-21-71 Red. Bore	1.5	24
08-18-58-68	2.0	18
01-11-51-61-21-71 Full Bore		43
01-11-51-61-21-71 Red. Bore		33
02-12-52-62		38
08-18-58-68-02-12-52-62	3.0	45
01-11-51-61-21-71 Full Bore		47
01-11-51-61-21-71 Red.		32
08-18-58-68-02-12-52-62	4.0	26
01-11-51-61-21-71 Full Bore		27
01-11-51-61-21-71 Red. Bore		23
51-61-71 - Stroke 2"	6.0	58
51-61-71 - Stroke 3"	6.0	47
51-61-71 - Stroke 4"	6.0	96
51-61-71 - Stroke 2"	8.0	52
51-61-71 - Stroke 4"	8.0	52

# 4. Electrical connections

## 4.1 Electrical Connection Safety Information



### Caution

Before commencement of any work to make the electrical please read to Section 1 "Safety Information".



### Warning

Mains connection and commissioning of the AEL7 Series actuator requires specialist knowledge of electrical circuits and systems, and the inherent dangers. A working knowledge of linear actuators is also required.

The operator is responsible for ensuring that safe systems of operation and practice are implemented and maintained. Only qualified personnel must be allowed to make the electrical power connections to the AEL7 Series actuator, and these personnel must be familiar with, and comply with the applicable health and safety standards or guidelines. Failure to do so could result in death, severe physical injuries or material damages to the actuator, valve and associated equipment.

- Ensure that the electrical power supply is isolated
- Safeguard against the unintentional switching on by ensuring that there is a safe system of practice in operation – e.g. lock the electrical supply isolator
- Ensure that any installation of any new power supply is compliant with local regulations
- Check the mains connection voltage and frequency for conformity to the actuator. Details of the requirements are identified on the AEL7 Series actuator nameplate which can be found on the actuator baseplate
- Ensure that the power supply cable is of the correct cross section for the maximum expected load. Details of the requirements are identified on the AEL7 Series actuator nameplate which can be found on the actuator baseplate, and in the Technical Information Sheet (TI-P713-02)
- Minimum cross section for the power supply cable is 1 mm<sup>2</sup>. Conductors below this area can result in operational disturbances (please note maximum cable core size 1.5 mm<sup>2</sup> for 1.2 kN actuators - larger cable cores can prevent the cover from seating correctly)
- Ensure that the power supply is correctly fused for the maximum expected load. Details of the requirements for each AEL7 Series actuator can be found in Tables 6 to 9

**Table 6 AEL7 Actuator Power Consumption – 230 Vac**

Actuator Nomenclature	Thrust	Spindle Speed	Power (W)	Nominal Current (A)	Starting Current (A)
AEL71111---	1 kN	0.2 mm/s	4.9	0.03	0.03
AEL71211---		0.3 mm/s	5.8	0.03	0.03
AEL72211---	2 kN	0.3 mm/s	5.8	0.03	0.03
AEL72211---		0.4 mm/s	11.0	0.05	0.05
AEL72231---		1.7 mm/s	64.4	0.28	0.28
AEL73211---	4 kN	0.4 mm/s	11.0	0.05	0.05
AEL73221---		0.8 mm/s	64.4	0.28	0.28
AEL74211---	6 kN	0.6 mm/s	51.5	0.23	0.23
AEL75311---	8 kN	0.7 mm/s	130.0	0.70	1.50
AEL75321---		1.2 mm/s	130.0	0.70	1.50
AEL76311---	12 kN	0.4 mm/s	51.5	0.23	0.23
AEL77311---	15 kN	0.4 mm/s	51.5	0.23	0.23
AEL78421---	20 kN	0.8 mm/s	206.0	0.93	2.10

**Table 7 AEL7 Actuator Power Consumption – 110 Vac**

Actuator Nomenclature	Thrust	Spindle Speed	Power (W)	Nominal Current (A)	Starting Current (A)
AEL71112---	1 kN	0.2 mm/s	4.9	0.05	0.05
AEL71212---		0.3 mm/s	5.7	0.06	0.06
AEL72212---	2 kN	0.3 mm/s	5.7	0.06	0.06
AEL72212---		0.4 mm/s	11.0	0.10	0.10
AEL72232---		1.7 mm/s	14.5	0.07	0.07
AEL73212---	4 kN	0.4 mm/s	11.0	0.10	0.10
AEL73222---		0.8 mm/s	14.5	0.07	0.07
AEL74212---	6 kN	0.6 mm/s	51.5	0.47	0.47
AEL75312---	8 kN	0.7 mm/s	110.0	1.10	2.20
AEL75322---		1.2 mm/s	110.0	1.10	2.20
AEL76312---	12 kN	0.4 mm/s	51.5	0.47	0.47
AEL77312---	15 kN	0.4 mm/s	51.5	0.47	0.47
AEL78422---	20 kN	0.8 mm/s	200.0	2.00	4.50

**Table 8 AEL7 Actuator Power Consumption – 24 Vac**

Actuator Nomenclature	Thrust	Spindle Speed	Power (W)	Nominal Current (A)	Starting Current (A)
AEL71113---	1 kN	0.2 mm/s	4.9	0.22	0.22
AEL71213---		0.3 mm/s	6.1	0.26	0.26
AEL72213---	2 kN	0.3 mm/s	6.1	0.26	0.26
AEL72213---		0.4 mm/s	11.0	0.47	0.47
AEL72233---		1.7 mm/s	50.4	2.10	2.10
AEL73213---	4 kN	0.4 mm/s	11.0	0.47	0.47
AEL73223---		0.8 mm/s	50.4	2.10	2.10
AEL74213---	6 kN	0.6 mm/s	49.5	2.06	2.06
AEL75313---	8 kN	0.7 mm/s	66.0	2.75	2.75
AEL75323---		1.2 mm/s	160	6.70	6.70
AEL76313---	12 kN	0.4 mm/s	49.5	2.06	2.06
AEL77313---	15 kN	0.4 mm/s	49.5	2.06	2.06
AEL78423---	20 kN	0.8 mm/s	4.9	0.22	0.22

**Table 9 AEL7 Actuator Power Consumption – 24Vdc**

Actuator Nomenclature	Thrust	Spindle Speed	Power (W)	Nominal Current (A)	Starting Current (A)
AEL71114---	1 kN	0.5 mm/s	10.8	0.45	1.53
AEL72224---	2 kN	0.8 mm/s	10.8	0.45	1.53
AEL72234---		1.7 mm/s	22.0	1.00	3.20
AEL73224---	4 kN	0.8 mm/s	17.0	0.70	4.00
AEL74224---	6 kN	0.8 mm/s	17.0	0.70	4.00
AEL75314---	8 kN	0.7 mm/s	26.5	1.10	9.50
AEL75324---		1.2 mm/s	26.5	1.10	9.50
AEL76314---	12 kN	0.4 mm/s	26.5	1.10	9.50
AEL77314---	15 kN	0.4 mm/s	48.0	2.00	13.00
AEL78424---	20 kN	1.0 mm/s	118.0	4.90	33.00

## 4.2 Removing the Actuator Cover

Remove cover retaining nut (and gasket when fitted) (16 mm A/F socket). For 1-6 kN actuators, hold both of the actuator pillars at the top. Using your thumbs gently ease the lid off.

For 8kN+ actuators, the cover will require a gentle anti-clockwise movement at the same time as a linear force to raise the cover from the actuator.



**Note:** When replacing the cover ensure that location thread and cover are correctly aligned. Gently lower the actuator cover until it meets the ingress seal. Firmly press down the actuator cover with a small clockwise movement of the cover to ensure correct engagement. Refit gasket and top nut and tighten.

## 4.3 Making the Electrical Connection

A terminal diagram for the actuator can be found inside the actuator cover and this issue of the Installation and Maintenance Instructions. The operator is responsible for ensuring that safe systems of operation and practice are implemented and maintained and the installation and maintenance instructions should form part of the standard operating procedures for maintenance and must therefore be kept in an accessible location and in a legible condition.

With the actuator coupled to a valve as described in Section 3, the actuator spindle in the fully extended position, the power supply safely isolated and the actuator cover removed

- Fit the correct cable gland for the location and remove the blanking plate (the AEL7 Series actuator is supplied with metallic cable glands that conform to IP65 enclosure ingress protection assuming that the correct diameter of cable is installed. If these are removed and replaced for any reason, these must be recycled responsibly).
- Feed the electrical power supply cable through the cable gland until enough length exists within the actuator to make all of the necessary connections easily.
- Mark the power supply cable approximately 10 mm above the actuator base plate, remove from the gland and carefully strip the outer casing and wrapping. Dispose of the waste responsibly.
- Strip the individual cores at a length of approximately 5mm from the end, and once the correct lengths of the individual cores has been established, the ends should be crimped with the correctly sized and insulated crimp terminals (flat or pin type).
- Guide the cores of the power supply cable through the gland sleeve and gland, and connect the cores to the actuator terminals as identified in the terminal diagrams below (or in the hood of the actuator) taking care to ensure that the routing of the cores protects them from damage of moving parts or from damage when replacing or removing the actuator cover.

## 4.4 Electrical Connection

Please refer to Figure 5 and Figure 6 for all 1-20 kN actuator electrical connections unless otherwise stated


Power Supply ( Vac )				Modulating Signal							
VMD				Positioner		Setpoint			Position Feedback		
11	14	1		54	55	57	56	59	58	60	61
▼	▲	-	-	-	-	-	▲	▲	-	▼	▼
L-	L+	N	PE	L	N	GND	V+	mA+	GND	mA+	V+
Direction Close	Direction Open	Neutral	Earth	Live	Neutral	Ground	Control Voltage	Control mA	Ground	Active Position feedback mA +	Active Position feedback V

Fig.5 AEL71-78 Vac Terminal Diagram

Power Supply (Vdc)				Modulating Signal					
VMD		Positioner		Setpoint			Position Feedback		
1	2	54	55	57	56	59	58	60	61
▲ / ▼	▼ / ▲	▲	▼	-	▲	▲	-	▼	▼
+ / -	- / +	+	-	GND	V+	mA+	GND	mA+	V+
Direction Close	Direction Open	Live	Neutral	Ground	Control Voltage	Control mA	Ground	Active Position feedback mA	Active Position feedback V

Fig.6 AEL71-78 Vdc Terminal Diagram

Options											
Heater		Potentiometer			Position Switches						
7	8	25	26	27	19	20	21	22	23	24	
-	-	▲	-	▼	-	-	-	-	-	-	
L	N	V+	S+	GND	(NC)	COM	(NO)	(NC)	COM	(NO)	
Heater		Feedback signal (passive)			Potential free position Switch S4			Potential free position Switch S5			

Options											
Heater		Potentiometer			Position Switches						
7	8	25	26	27	19	20	21	22	23	24	
-	-	▲	-	▼	-	-	-	-	-	-	
+	-	V+	S+	GND	(NC)	COM	(NO)	(NC)	COM	(NO)	
Heater		Feedback signal (passive)			Potential free position Switch S4			Potential free position Switch S5			



Power Supply			Positioner			Modulating Signal					
						Setpoint			Position Feedback		
A1	A2		A4	A5	A6	59	57	56	60	58	61
-	-		-	-	-	▼/▲	-	▼/▲	▼/▲	-	▼/▲
L / +	N / -	PE	-	-	-	mA+	GND	V+	mA+	GND	V+
Power supply (L / 24 VDC +)	Power Supply (N / 24 VDC -)	 Earth	Not in Use	Not in Use	Not in Use	Control input 0(4) – 20 mA	Ground	Control input 0(2) – 10V	Active position feedback mA	Ground	Active position feedback V

Fig.7 AEL72-78 Vac/Vdc Terminal Diagram – Actuators with Shutdown Module

	<p><b>AEL7 Actuators Supplied with Shutdown Module are internally hard wired</b>  Please refer to Figure7 (AEL72-78 Vac/Vdc Terminal Diagram with Shutdown Module) to ensure that the correct Supply Voltage is applied to the correct terminal within the shutdown module itself. The Shutdown Module is hardwired in the factory to the actuator terminals. There is NO requirement to connect any wiring to terminals within the actuator cover.</p>
---	---

Options											
Heater		Potentiometer			Position Switches						
8	9	25	26	27	19	20	21	22	23	24	
-	-	▲	-	▼	-	-	-	-	-	-	
L	N	V+	S+	GND	(NC)	COM	(NO)	(NC)	COM	(NO)	
Heater		Feedback signal (passive)			Potential free position Switch S4			Potential free position Switch S5			

valvesgo.com

# 5. Actuator Accessories

## 5.1 Actuator Accessory Safety Information



### Caution

Before commencement of any work to inspect, install, commission, remove or modify any of the AEL7 Series actuator accessories, please read to Section 1 "Safety Information". and Section 4.1 "Electrical Connection Safety Considerations".

In order to select the correct accessories for each actuator, refer to Table 10. and Table 11. The AEL7 Series actuators are modular (based on frame size). However for actuators that require a positioner card, it is recommend that the actuators are supplied fitted with the positioner card direct from the factory.

**Table 10 VMD Actuator Accessories**

Actuator Type	Thrust	Voltage	Heater	Aux. switch	Potentiometer
AEL7 VMD	1 kN	230 Vac	AEL7X181	AEL7X016	AEL7X001 <sup>1</sup>
		110 Vac			
		24 Vac	AEL7X183		
		24Vdc			
	2-4 kN	230 Vac	AEL7X191	AEL7X010	AEL7X002 <sup>1</sup>
		110 Vac			
		24 Vac	AEL7X193		
		24Vdc			
	6 kN	230 Vac	AEL7X201	AEL7X011	AEL7X003 <sup>1</sup>
		110 Vac			
		24 Vac	AEL7X203		
		24Vdc			
	8-20 kN	230 Vac	AEL7X211	AEL7X012	AEL7X004
		110 Vac			
		24 Vac	AEL7X213		
		24Vdc			

**Table 11 Modulating Actuator Accessories**

Actuator Type	Thrust	Voltage	Positioner <sup>2</sup>	Heater	Aux. switch	Potentiometer
AEL7 VMP	1 kN	230 Vac	AEL7X241	AEL7X181	AEL7X017	AEL7X001 <sup>1</sup>
		110 Vac				
		24 Vac	AEL7X233	AEL7X183		
		24Vdc	AEL7X224			
	2-4 kN	230 Vac	AEL7X241	AEL7X191	AEL7X014	AEL7X002 <sup>1</sup>
		110 Vac				
		24 Vac	AEL7X233	AEL7X193		
		24Vdc	AEL7X224			
	6 kN	230 Vac	AEL7X241	AEL7X201	AEL7X015	AEL7X003 <sup>1</sup>
		110 Vac				
		24 Vac	AEL7X233	AEL7X203		
		24Vdc	AEL7X224			
	8-20 kN	230 Vac	AEL7X241	AEL7X211	AEL7X012	AEL7X004
		110 Vac				
		24 Vac	AEL7X233	AEL7X213		
		24Vdc	AEL7X224			

<sup>1</sup> Requires Auxiliary switch assembly

<sup>2</sup> Requires potentiometer

## 5.2 Auxiliary Travel Switches

The AEL7 Series actuator can be equipped with auxiliary travel switches. The auxiliary travel switch is only a means of providing a Volt Free Contact enabling the user to identify when the actuator is in a user defined position. The auxiliary travel switches do not impact actuator stroke and be configured as either Normally Open (NO) or Normally Closed (NC).

### 5.2.1 Installation of Auxiliary Travel Switches: 1-6 kN Actuators



#### Caution

Before commencement of any work to inspect, install, commission, remove or modify the auxiliary travel switches, please read to Section 1 "Safety Information" and Section 4.1 "Electrical Connection Safety Considerations".

With the actuator spindle in the fully extended position, the power supply safely isolated and the actuator cover removed:

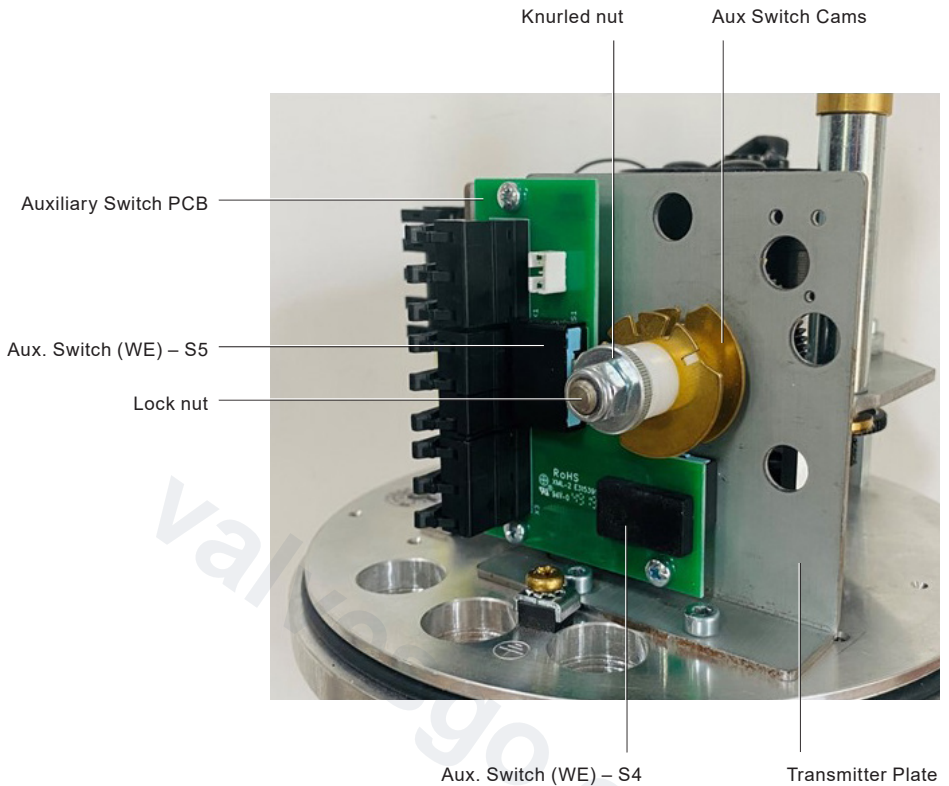
- Check the switch kit for completeness and signs of damage. Reject any damaged parts immediately
- Couple the fixed feedback bar directly to the driving rod of main actuator spindle. See Figure 8 "Auxiliary Travel Switch Feedback Arrangement (1-6 kN)" for product orientation
- Assemble the transmitter plate complete with auxiliary travel switches to the actuator base plate. See Figure 9 "Auxiliary Travel Switch Arrangement (1-6 kN)" for product orientation
- The auxiliary travel switches are internally connected to the terminal rail
- Configure and connect the switches to the control system as shown in Figure 11 Auxiliary Travel Switch terminal Diagram

Potentiometer cam

Feedback bar



**Fig. 8**  
**Auxiliary Travel Switch (WE)**  
**Feedback Arrangement (1-6 kN)**



**Fig. 9 Auxiliary Travel Switch (WE) Arrangement (1-6 kN)**



**Caution**

The setting of the feedback bar to the correct position is important in order to get maximum resolution of the potentiometer when fitted and to provide uninterrupted switching of the auxiliary contacts. The correct setting can be achieved when the potentiometer cam is 2-3 mm from the actuator base plate with the actuator spindle fully extended.

## 5.2.2 Installation of Auxiliary Travel Switches: 8-20 kN Actuators



### Caution

Before commencement of any work to inspect, install, commission, remove or modify the auxiliary travel switches, please read to Section 1 "Safety Information" and Section 4.1 "Electrical Connection Safety Considerations".

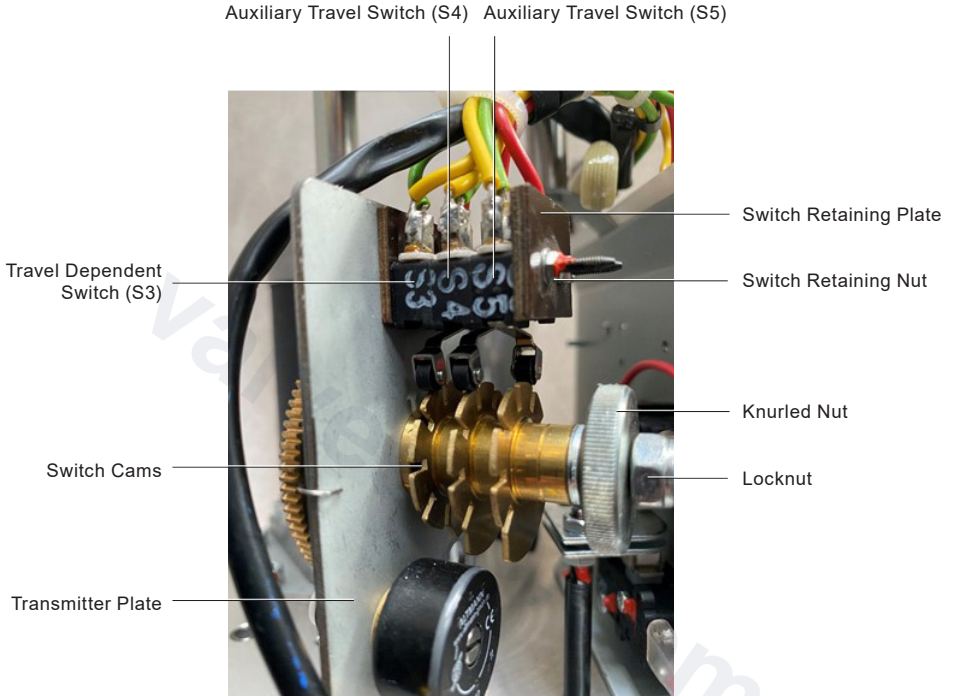
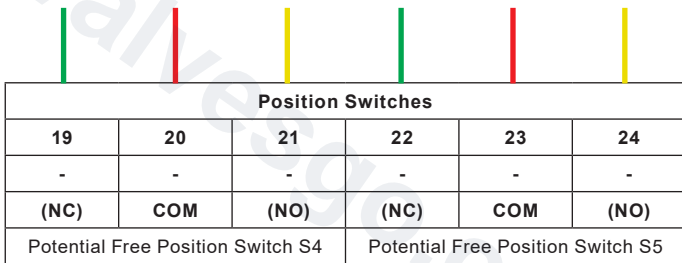


Fig. 10 Auxiliary Travel Switch (WE) Arrangement (8 kN+)

With the actuator spindle in the fully extended position, the power supply safely isolated and the actuator cover removed:

- Check the switch kit for compatibility, completeness and signs of damage. Reject any damaged parts immediately
- Refer to Figure 10 for product orientation
- Remove switch retaining nuts and switch retaining plate
- Slide switch S4 first onto the switch retaining pins ensuring that orientation is as shown in Figure 8
- The location spigot of switch S3 must snap into the corresponding alignment hole of switch S4
- Slide switch S5 onto the switch retaining pins ensuring that orientation is as shown in Figure 8
- The location spigot of switch S4 must snap into the corresponding alignment hole of switch S5
- Replace the switch retaining plate and tighten the switch retaining nuts
- Connect the wiring harness from switch S4 to terminals 19-21, and switch S5 to terminals 22-24 as shown in Figure 11 Auxiliary Travel Switch Terminal Diagram
- Configure the switches to the control system is also shown shown in Figure 11 Auxiliary Travel Switch Terminal Diagram



**Fig. 11 Auxiliary Travel Switch Terminal Diagram**

## 5.3 Potentiometer

The potentiometer is used to provide a 0-10Vdc feedback of actuator (valve) position for VMD actuators and to provide the internal position feedback for actuators fitted with a positioner card. For position feedback for actuators fitted with a positioner card see Section 6.4.

For 1 – 6 kN actuators, the potentiometer operates via use of the same fixed feedback bar coupled directly to the driving rod of main actuator spindle that is used to operate the auxiliary travel switches and therefore requires the auxiliary switch transmitter plate to be installed in order to mount the potentiometer. For 8 – 20 kN actuators, the potentiometer operates via use of an adjustable stroke arm coupled directly to the driving rod of main actuator spindle.



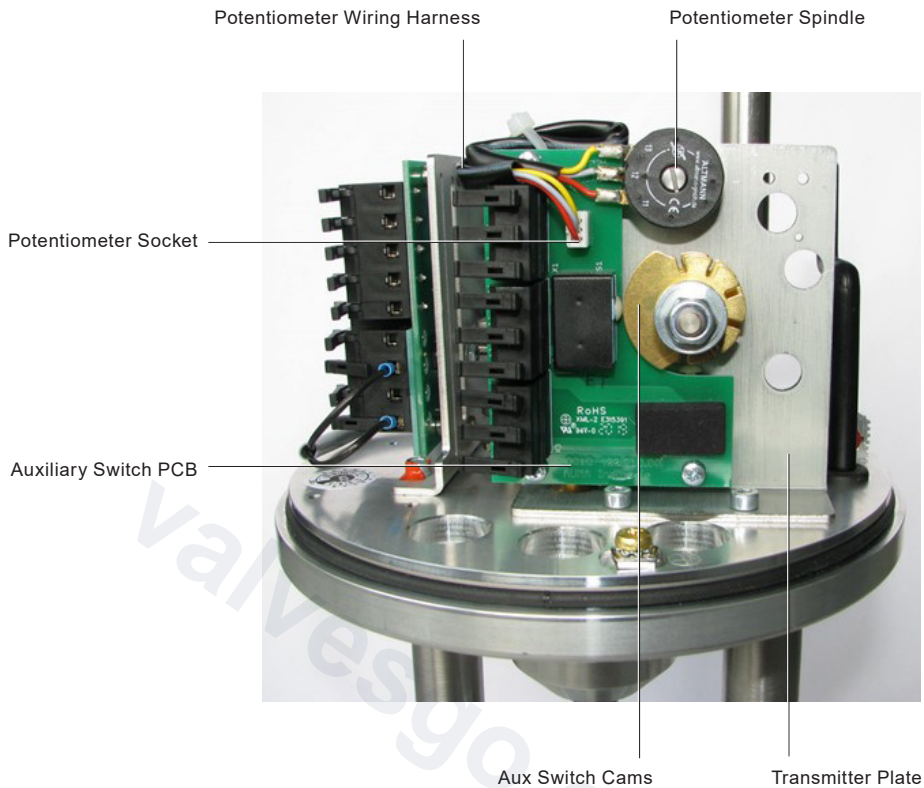
### Caution

Before commencement of any work to inspect, install, commission, remove or modify the potentiometer, please read to Section 1 "Safety Information" and Section 4.1 "Electrical Connection Safety Considerations".

### 5.3.1 Installation of Potentiometer (1 - 6 kN)

With the actuator spindle in the fully extended position, the power supply safely isolated and the actuator cover removed:

- Check the potentiometer kit for compatibility, completeness and signs of damage. Reject any damaged parts immediately
- Refer to Figure 12 Potentiometer Installation and Adjustment (1 – 6 kN) for product orientation
- Remove circlip and pinion from the potentiometer
- Remove the lock nut and washer from the potentiometer
- Slide the potentiometer and spacer ring through the transmitter plate
- Loosely replace the washer and lock nut
- Slide the pinion onto the potentiometer shaft, taking care to ensure that the mesh with the stroke pinion is correct
- Tighten the lock nut
- Connect the wiring harness to the potentiometer socket as detailed in Figure 12 Potentiometer Installation and Adjustment (1-6 kN)
- Using an insulated terminal screwdriver, carefully turn the potentiometer fully clockwise in order to zero the device (confirm with a measurement instrument if necessary)



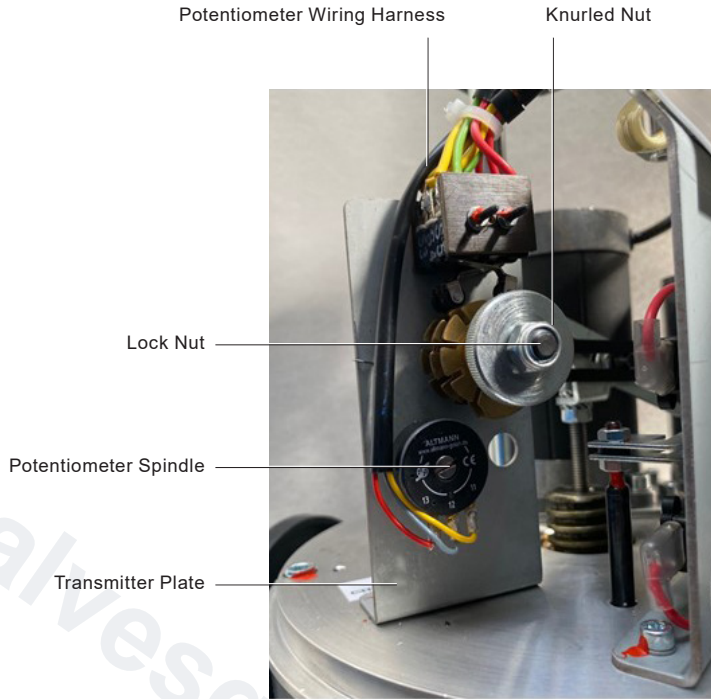
**Fig. 12 Potentiometer Installation and Adjustment (1-6 kN)**

### 5.3.2 Installation of Potentiometer (8 - 20 kN)

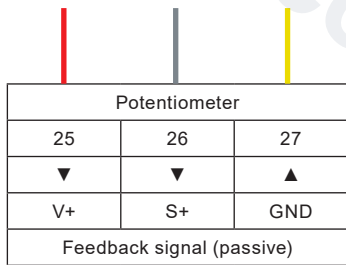
With the actuator spindle in the fully extended position, the power supply safely isolated and the actuator cover removed:

- Check the potentiometer kit for compatibility, completeness and signs of damage. Reject any damaged parts immediately
- Refer to Figure 13 Potentiometer Installation and Adjustment (8 kN+) for product orientation
- Remove circlip and pinion from the potentiometer
- Remove the lock nut and washer from the potentiometer
- Slide the potentiometer and spacer ring through the transmitter plate
- Loosely replace the washer and lock nut
- Slide the pinion onto the potentiometer shaft, taking care to ensure that the mesh with the stroke pinion is correct
- Tighten the lock nut
- Connect the wiring harness to the terminals as detailed in Figure 14 Potentiometer Terminal Diagram
- Using an insulated terminal screwdriver, carefully turn the potentiometer fully spindle clockwise in order to zero the device (confirm with a measurement instrument if necessary)

valvesgo.com



**Fig. 13 Potentiometer Installation and Adjustment (8kN+)**



**Fig. 14 Potentiometer Terminal Diagram**

## 5.4 Anti-Condensation Heater

The anti-condensation heater must be used as protection against the formation of condensation within the actuator cover in the case of:

- Strongly varying ambient temperatures
- High air humidity
- Outdoor application

The anti-condensation heater is an automatic device containing a thermostat and therefore does not require commissioning. The thermostat operates with a switch-on temperature of +40°C and a switch-off temperature of +60°C.



### Caution

Before commencement of any work to inspect, install, commission, remove or modify the anti-condensation heater, please read to Section 1 "Safety Information" and Section 4.1 "Electrical Connection Safety Considerations".



### Warning

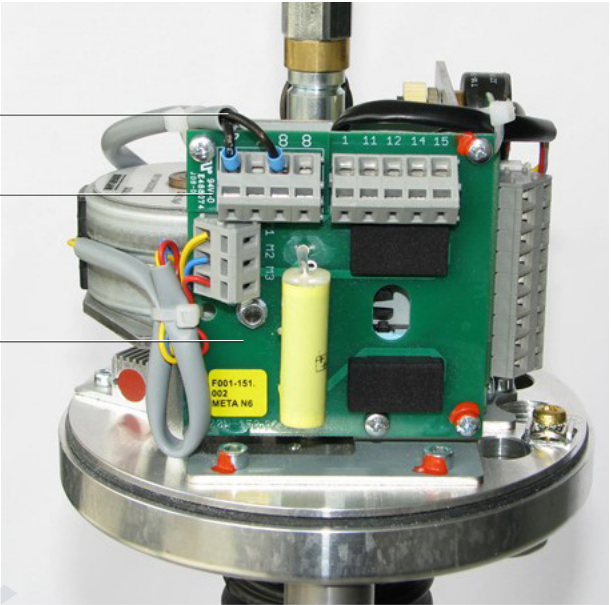
The anti-condensation heater can become very hot and easily burn. Care should be taken, gloves worn and the heater allowed sufficient time to cool before handling.

### 5.4.1 Installation of Anti-Condensation Heater (1 – 6 kN)

With the actuator spindle in the fully extended position, the power supply safely isolated and the actuator cover removed:

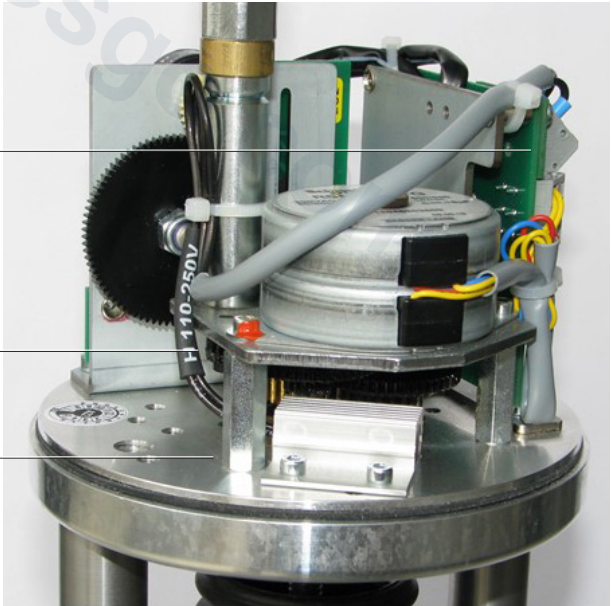
- Check the anti-condensation heater kit for compatibility, completeness and signs of damage. Reject any damaged parts immediately
- Refer to Figures 15 to 20 "Heater Installation 1 - 6 kN" for product orientation and fix the anti-condensation terminal board to the main board with the screws supplied
- Fix the heater to the main terminal plate as indicated with the M3 screws provided
- Connect the wires as indicated in Figure 23 Anti-Condensation Heater Terminal Diagram and cable tie the wiring harness carefully as indicated

- Anti-Condensation Heater Wiring Harness
- Anti-Condensation Heater Terminal Board
- Main Board

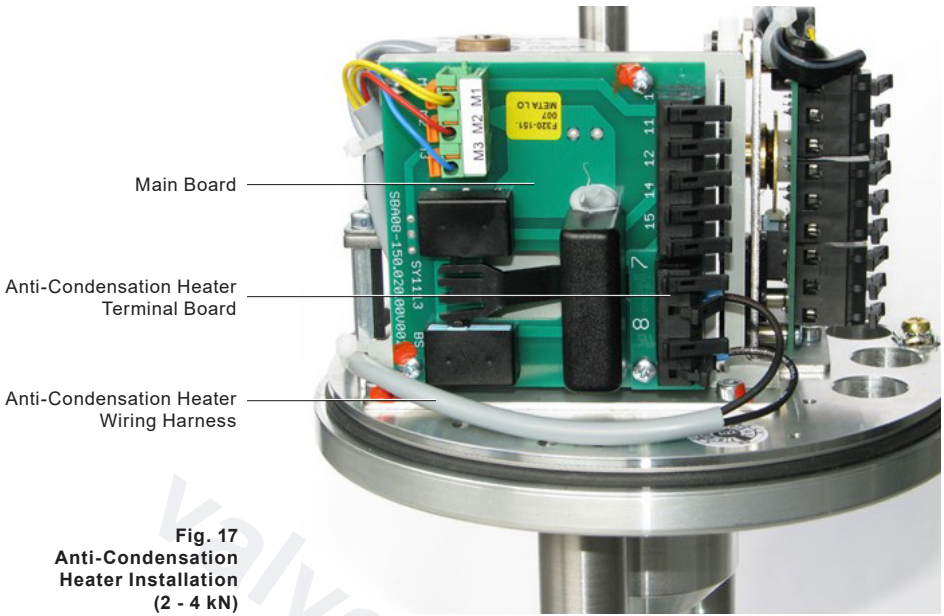


**Fig. 15**  
Anti-Condensation Heater Installation (1kN)

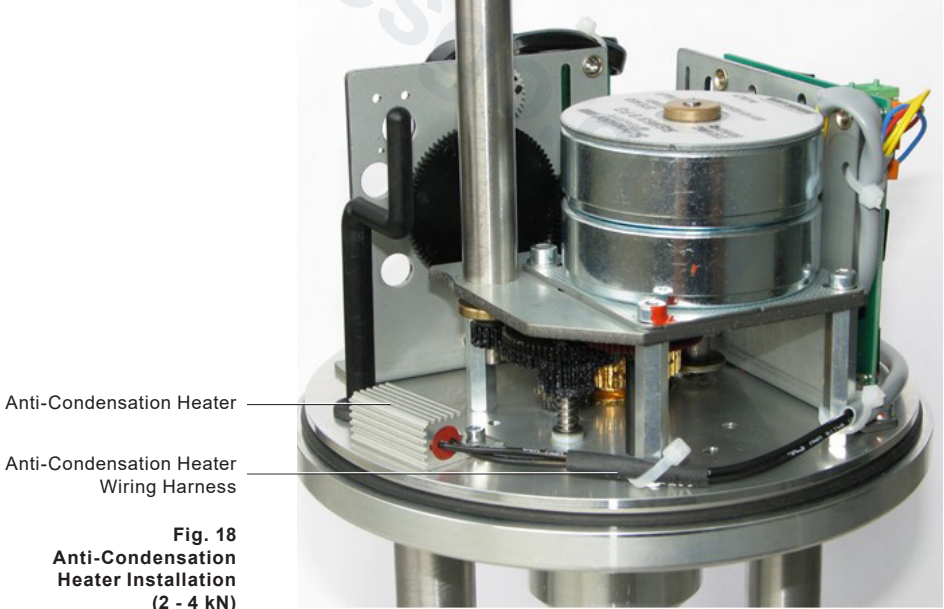
- Main Board
- Anti-Condensation Heater Wiring Harness
- Anti-Condensation Heater



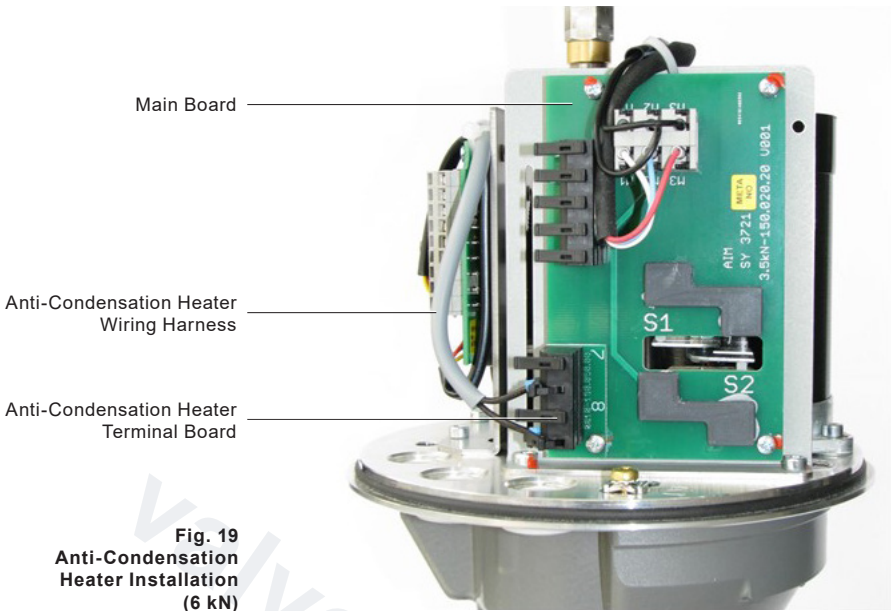
**Fig. 16**  
Anti-Condensation Heater Installation (1 kN)



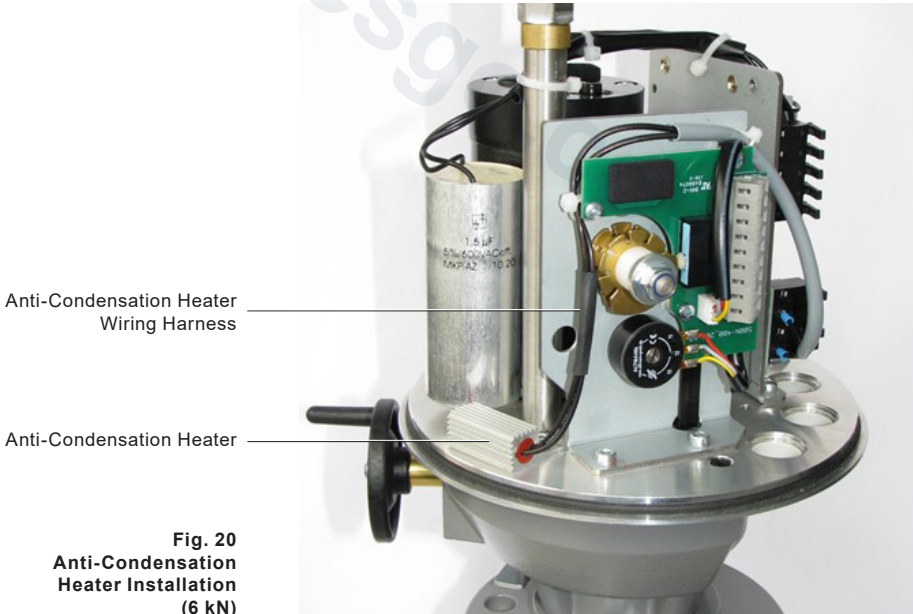
**Fig. 17**  
**Anti-Condensation**  
**Heater Installation**  
**(2 - 4 kN)**



**Fig. 18**  
**Anti-Condensation**  
**Heater Installation**  
**(2 - 4 kN)**



**Fig. 19**  
**Anti-Condensation**  
**Heater Installation**  
**(6 kN)**

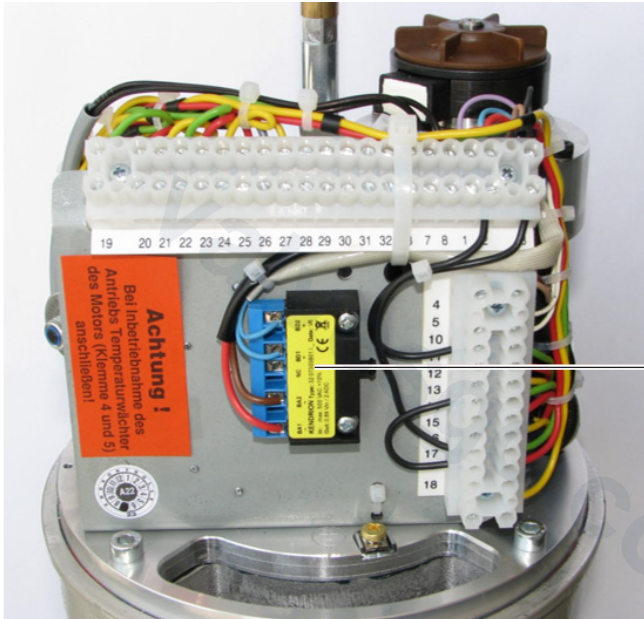


**Fig. 20**  
**Anti-Condensation**  
**Heater Installation**  
**(6 kN)**

### 5.4.2 Installation of Anti-Condensation Heater (8 – 20 kN)

With the actuator spindle in the fully extended position, the power supply safely isolated and the actuator cover removed:

- Check the anti-condensation heater kit for compatibility, completeness and signs of damage. Reject any damaged parts immediately
- Refer to Figures 21 and 22 "Heater Installation 8-20 kN" for product orientation
- Fix the heater to the main terminal plate as indicated with the M3 screws provided
- Connect the wires as indicated in Figure 23 Anti-Condensation Heater Wiring Diagram



Anti-Condensation Heater Terminal Board

Fig. 21 Anti-Condensation Heater Installation (8-20 kN)

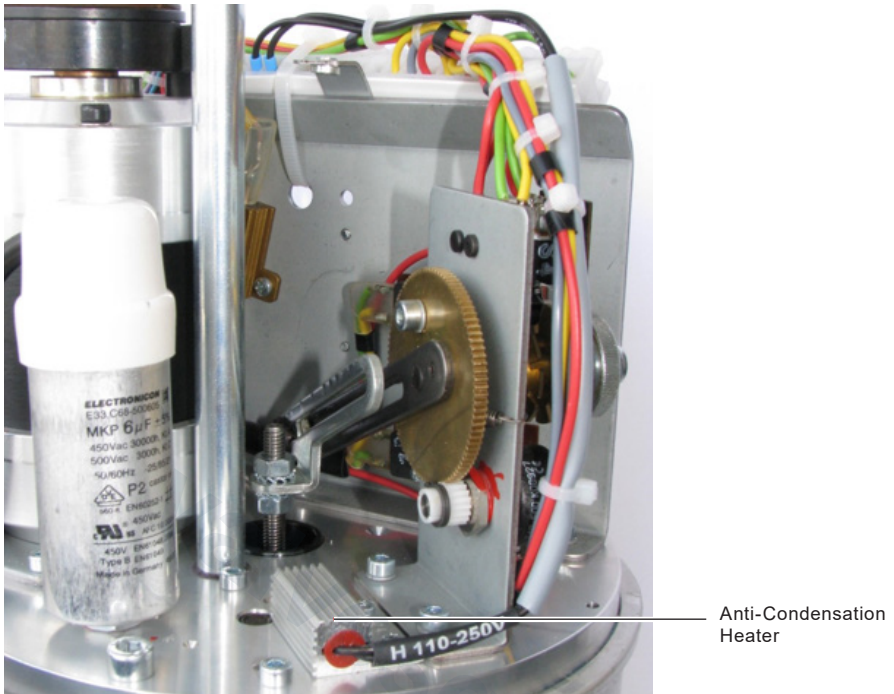


Fig. 22 Anti-Condensation Heater Installation (8-20 KN)

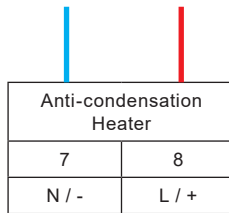


Fig. 23 Anti-Condensation Heater Terminal Diagram

## 5.5 Positioner Card

The AEL7 Series actuator can be used for modulating control by use of a positioner card (requires potentiometer). The positioner card can be configured to mA or Vdc input signals. The positioner card will also provide a position feedback (mA or Vdc). Please refer to section 6.4 Positioner Card Commissioning for details.

It is always recommended to purchase the AEL7 with positioner card fitted. When converting a VMD actuator to modulating control, refer to Table 10 in Section 5.1 to select the correct conversion kit. A conversion kit is not required when a positioner is being replaced.

### 5.5.1 Installation of Positioner Card



#### Caution

Before commencement of any work to inspect, install, commission, remove or modify the positioner card, please read to Section 1 "Safety Information" and Section 4.1 "Electrical Connection Safety Considerations".



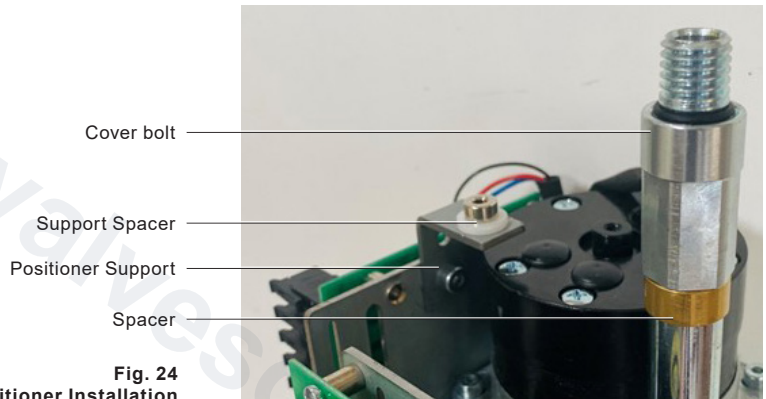
#### Warning

Mains connection and commissioning of the AEL7 Series actuator requires specialist knowledge of electrical circuits and systems, and the inherent dangers. A working knowledge of linear actuators is also required.

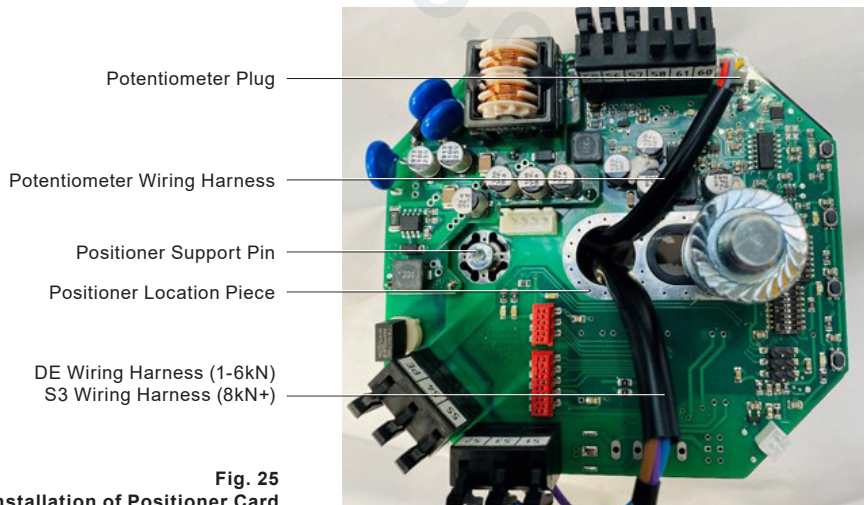
With the actuator spindle in the fully extended position, the power supply safely isolated and the actuator cover removed:

- Check the positioner kit for completeness and signs of damage. Reject any damaged parts immediately
- Fix the Positioner Support to the main board plate with the pin supplied (Figure 24)
- Remove the top section of the cover bolt to expose a thread
- Remove the spacer and recycle responsibly
- Slide a single washer from the positioner kit over the exposed cover bolt thread
- Slide the positioner guard and the positioner location piece over the exposed cover bolt thread
- Carefully slide the positioner card over the exposed cover bolt thread, followed by the second washer
- Replace the top section of the cover bolt thread and tighten taking care to ensure that the actuator cover can fit over the positioner card once the cable cores are terminated
- Fix the Positioner Card to the Positioner Support taking care to ensure that the Support Spacer is fitted
- Plug one end of the wiring harness to the potentiometer terminal on the positioner card
- 1 – 6 kN: Connect the potentiometer plug to the potentiometer socket on the positioner card referring to Figure 25 "Installation of Positioner Card" for product orientation. The potentiometer wiring harness should be fed through the center of the positioner card as shown
- 1 - 6 kN: Connect the DE wiring harness (orientation shown in Figure 25) as indicated in Figure 26 "Positioner Installation Terminal Diagram (1 - 6 kN)"

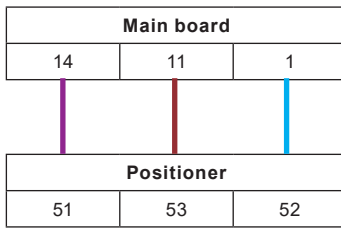
- 8 kN+: Connect the cores of the potentiometer wiring harness to the main terminal rail (Figure 27), and connect the potentiometer plug to the potentiometer socket on the positioner card referring to Figure 25 "Installation of Positioner Card" for product orientation. The potentiometer wiring harness should be fed through the center of the positioner card as shown
- 8 kN+: Connect the DE wiring harness as indicated in Figure 27 "Positioner Installation Terminal Diagram (8+ kN)"
- Refer to Figure 5 to Figure 7 to connect the positioner card to the electrical power supply and the control signal
- Refer to Section 6.4 for commissioning the positioner card within the actuator



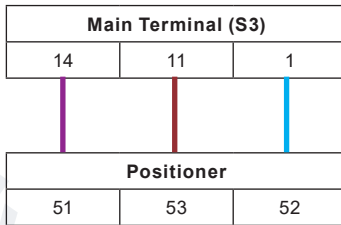
**Fig. 24**  
**Positioner Installation**



**Fig. 25**  
**Installation of Positioner Card**



**Fig. 26 Positioner Installation Terminal Diagram (1 – 6 kN)**



**Fig. 27 Positioner Installation Terminal Diagram (8 kN+)**

valvesgo.com

# 6. Commissioning

## 6.1 Commissioning Safety Information



### Caution

Before commencement of any commissioning work, please read to Section 1 "Safety Information" and Section 4.1 "Electrical Connection Safety Considerations".



### Warning

Main connection and commissioning of the AEL7 Series actuator requires specialist knowledge of electrical circuits and systems, and the inherent dangers. A working knowledge of linear actuators is also required.

Risk of injury by moving parts. Ensure that the control system is disabled and the electrical power supply is isolated to ensure that the valve and actuator do not move without warning. The incorrect use of power supplies to assist the installation, commissioning and maintenance of electrically actuated valve assemblies increases the risk of personal injury.

### Warning - crush hazard

**Do not** place hands within the actuator yoke or on the stem when isolation of the electrical power supply has been removed.

**Do not** attempt to restrict actuator stroke or movement, or increase seat load through the placing of objects within the actuator yoke. This practice could also result in the **loss of sight**.

## 6.2 Adjustment of Travel Dependent Switch S3 (8-20 kN actuators only)



### Caution

Before commencement of any work to inspect, install, commission, remove or modify the travel dependent switch, please read to Section 1 "Safety Information" and Section 4.1 "Electrical Connection Safety Considerations".

The 8-20 kN AEL7 Series actuators are supplied with three switch cams. One is for the travel dependent switch (S3 – used to limit the actuator stroke for larger thrust actuators when used on shorter stroke valves). The remaining two cams are for the auxiliary switched (S4 and S5). Please refer to Figure 9 for product orientation.

- Manually drive the actuator to the desired maximum stroke (retracted) position
- Loosen the knurled nut up to the lock nut
- Carefully insert an insulated terminal screwdriver in one of the S3 cam slots and turn the cam slowly until the point that the switch S3 is just made (confirm with a measurement instrument if necessary)
- Tighten the knurled nut



**Note:** The lock nut must not be moved. If the cams are tight to move, hold the travel lever in position rather than the lock nut.

For situations when the travel dependent switch is not going to be used, ensure that the setting of this switch does not interfere with setting of the valve, actuator or positioner card.

## 6.3 Adjustment of Auxiliary Travel Switch



### Caution

Before commencement of any work to inspect, install, commission, remove or modify the auxiliary travel switches, please read to Section 1 "Safety Information", Section 4.1 "Electrical Connection Safety Considerations" and Section 6.1 "Commissioning Safety Information".

The 1- 6 kN AEL7 Series actuators are supplied with two auxiliary switch cams (S4 and S5). The 8-20 kN AEL7 Series actuators are supplied with three switch cams as standard. The S4 and S5 auxiliary travel switches can be used to notify the user of a user defined valve and actuator position by means of a volt free contact (VFC). Refer to Figures 9 and 10 for product orientation. Refer to Section 6.2. for the setting of S3.


- Manually drive the actuator to the desired valve open position (retracted) position
- Loosen the knurled nut up to the lock nut
- Carefully insert an insulated terminal screwdriver in one of the S4 cam slots and turn the cam slowly until the point that the switch S4 is just made (confirm with a measurement instrument if necessary)
- Manually drive the actuator to the desired valve closed position (extended) position
- Carefully insert an insulated terminal screwdriver in one of the S5 cam slots and turn the cam slowly until the point that the switch S5 is just made (confirm with a measurement instrument if necessary)
- Tighten the knurled nut
- Refer to Figure 11 Auxiliary Travel Switch Terminal Diagram to ensure that the VFC is correctly configured to the control system requirement (NO or NC)




The lock nut must not be moved. If the cams are tight to move, hold the travel lever in position rather than the lock nut.

For situations when the travel dependent switch is not going to be used, ensure that the setting of this switch does not interfere with setting of the valve, actuator or positioner card.

## 6.4 Auxiliary Position Switch – Actuators with Shutdown Module

	<p><b>All Actuators Supplied with Shutdown Module</b> All AEL7 actuators supplied with a Shutdown Module use the Auxiliary Travel Switches for the operation of the actuator. This impacts the use of these switches as a position feedback option.</p> <p>For 2-6 kN actuators supplied with Shutdown Module, no Auxiliary Travel Switch can be set. There also is no option for further Auxiliary Travel Switches.</p> <p>For 8-20 kN actuators, one Auxiliary Travel Switch can be configured to indicate actuator position. This <b>MUST</b> only be set once final commissioning to a valve has been achieved:</p> <ul style="list-style-type: none"><li>- Auxiliary Travel Switch S2.5 can be used to indicate actuator extend position</li><li>- Auxiliary Travel Switch S2.4 can be used to indicate actuator retract position</li></ul>
---	--

	<p><b>Warning: 8-20kN Actuators Supplied with Shutdown Module</b> If an Auxiliary Travel Switch has been moved to indicate actuator (and valve) position, the switch must be reinstated at a position just beyond the limit of standard valve travel if the actuator is to be removed from valve. This is to prevent irreparable actuator damage – the Auxiliary Travel Switches are used to prevent the actuator from extending or retracting the actuator spindle beyond the limits of the gearbox.</p>
---	---

## 6.5 Commissioning of Positioner Card



### Caution

Before commencement of any work to inspect, install, commission, remove or modify the positioner card, please read to Section 1 "Safety Information", Section 4.1 "Electrical Connection Safety Considerations" and Section 6.1 "Commissioning Safety Information".



### Warning

Do not use the hand wheel or hand crank when either electrical power supply of control signal are applied. The actuator may respond to manual interaction resulting in muscular-skeletal damage to fingers.



### Caution

It is possible to damage the force dependent switches by applying excessive load by use of the hand wheel or hand crank.

The positioner card requires a potentiometer to be fitted in order to operate. The positioner card is fitted with a series of DIP switches that can be used to configure:

- Input signal
- Feedback signal
- Direction of action
- Hysteresis
- Failure mode (loss of control signal only)
- Seating (commissioning) function



The positioner electronics card (all voltages) can only be set for split range applications at the factory. Please contact your local Spirax Sarco Sales Office with a completed TI-P713-06 (AEL7 Split Range Application Request).

## 6.6 Vac Positioner Electronics Card (Excluding Shutdown Module Versions)

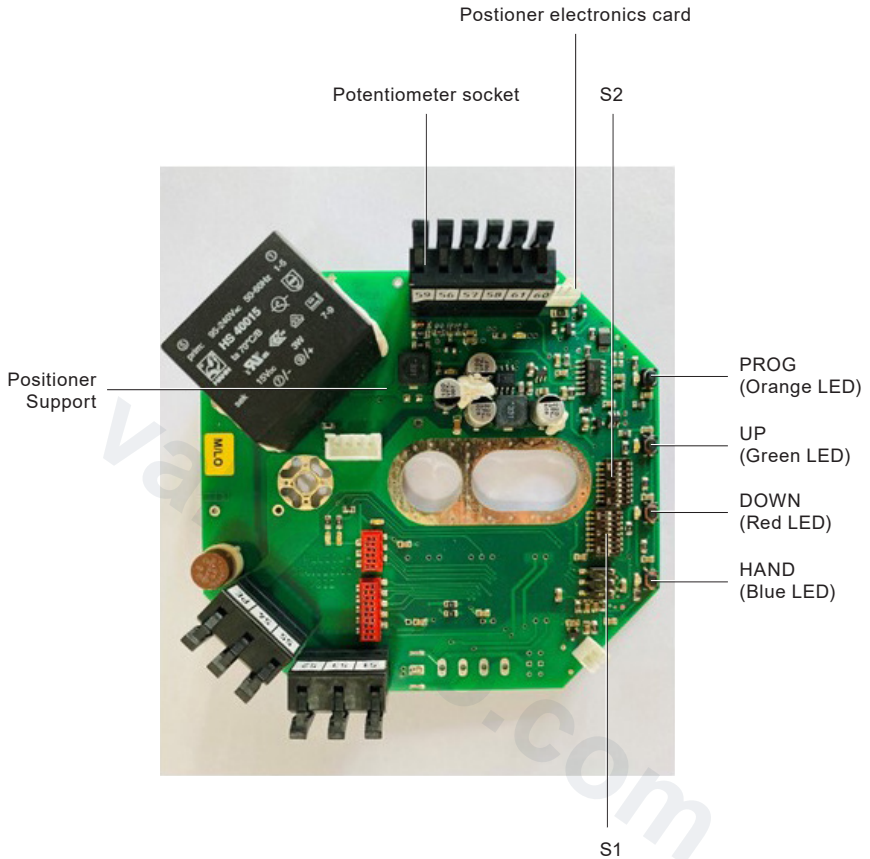


Fig. 28 Vac Positioner Electronics Card



The setting of DIP switches will be updated after power on or reset by simultaneous pressing HAND+UP+DOWN+PROG buttons.

**Table 12 DIP Switch Configuration**

DIP switch SW1			
Switch Nr.	Function	OFF	ON
S1.1	Setting of stroke	Off	On
S1.2	Action	Direct *	Reverse
S1.3 S1.4	Potentiometer	Internal *	n/a
S1.5	Signal range	4-20mA / 2-10 V*	0-20mA / 0-10V
S1.6	n/a	n/a	
S1.7 S1.8	Hysteresis	See Table 13	

DIP switch SW2			
Switch Nr.	Function	OFF	ON
S2.1	AUTOTUNE	Off	On
S2.2 S2.3 S2.4	n/a	n/a (set to Off)	
S2.5 S2.6	Failure mode	See Table 14	
S2.7 S2.8	Seating	See Table 15	

**Table 13 Hysteresis Configuration**

S1.7	S1.8	Hysteresis
Off*	Off*	1.5%
On	Off	1.0%
Off	On	0.5%
On	On	0.3%

**Table 15 End Position Configuration**

S2.7	S2.8	Seating
Off*	Off*	WE/WE
On	Off	DE/WE
Off	On	WE/DE
On	On	DE/DE

**Table 14 Failure Mode Configuration**

S2.5	S2.6	Failure mode
Off*	Off*	Extend
On	Off	Fail in place
Off	On	X=100%
On	On	X=0%

\* Indicates default setting

## 6.7 AUTOTUNE – Quick Set-Up (Vac excluding Shutdown Module Versions)

For the majority of applications a quick set-up routine can be adopted.

With the actuator spindle in the fully extended position, the power supply safely isolated and the actuator cover removed:

- Ensure that the potentiometer is in the zero position (confirm with a measurement instrument if necessary)
- For actuators fitted with a Travel Dependent Switch (S3), set S3 at a position corresponding to required travel
- With reference to Table 12 "DIP Switch Configuration"
- Select the action required with S1.2 (default is actuator stem extended at minimum input signal)
- Select the control signal required with S1.5 (default is 4-20mA / 2-10V) – Note: the feedback signal from the positioner automatically updates to the chosen input signal
- It is recommended that the hysteresis remain at 1.5% except in exceptional circumstances (refer to Table 13 Hysteresis Configuration)
- Select the desired failure mode. This function requires the power supply to still be operational. For Steam systems, it is recommended that both S2.5 and S2.6 be set to "OFF" (Table 14 Failure Mode Configuration)
- Set both S2.7 and S2.8 to "ON" (Table 15 End Position Configuration). This will allow the positioner to operate the valve through the full stroke, using the two physical force dependent (torque) switches to determine the end position of the actuator stroke in both ways i.e. it uses the end stops within the valve in order to determine stroke. The force dependent switches do not require any adjustment to correspond to valves with different lengths of stroke
- Manually move the valve off its seat approximately 20-50%



### Warning

The AUTOTUNE function will cause the valve and actuator to move. Make certain that all outcomes have been properly accounted for. The AUTOTUNE function can be stopped by pressing and holding any button during the commissioning cycle

- When it has been identified as safe to do so, reconnect the power to the actuator
- Set S2.1 to ON
- Press and hold "PROG" button for 3 seconds (orange LED flashes, turning solid with solid red and solid green LED)
- Press "HAND" button (blue LED illuminates)
- The actuator will retract until the lower force dependent switch is made as a result of the valve limits
- The actuator will then extend until the upper force dependent switch is made as a result of the valve limits (or S3 if fitted and set)
- When commissioning is complete, the red and green LEDs will switch off; "PROG" LED which will flash.
- Set S2.1 to OFF and apply a modulating signal. The actuator movement will now correspond to the input signal



If any changes are made to the positioner electronics card after final commissioning has been made, PRESS the PROG, UP, DOWN and HAND buttons once simultaneously to adopt the revised settings.

## 6.8 AUTOTUNE – Setting the Stroke with Positioner Card (Vac excluding Shutdown Module Versions)

For some applications it may be necessary to set the stroke of the actuator to suit a given application or valve.

With the actuator spindle in the fully extended position, the power supply safely isolated and the actuator cover removed:

- Ensure that the potentiometer is in the zero position (confirm with a measurement instrument if necessary)
- Manually move the valve off its seat approximately 20-50%
- With reference to Table. 12 "DIP Switch Configuration", set S2.7 and S2.8 to "OFF"
- Set S1.1 to "ON" (RED and GREEN LED will flash continuously)
- Press "HAND" button (Blue LED illuminates)
- Press "UP" button and retract actuator to the desired 100% travel
- Press "PROG" and "UP" simultaneously for 5s to set 100% (orange LED flashing and red LED illuminates slowly)
- Press "DOWN" button and extend actuator to the desired 0% travel
- Press "PROG" and "DOWN" simultaneously for 5s to set 100% (orange LED flashing and green LED illuminates)
- Stroke is now set
- Set S1.1 to "OFF"
- Apply a modulating signal. The actuator movement will now correspond to the input signal

# 6.9 Vdc Positioner Electronics Card (Including Shutdown Module Versions)

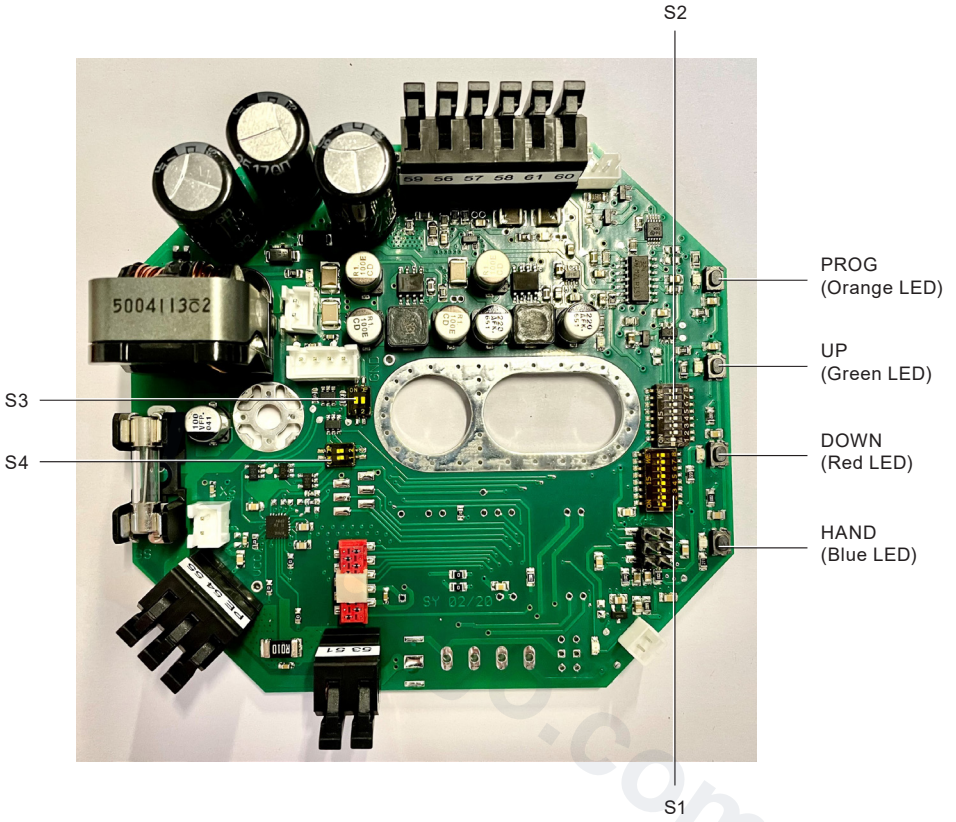


Fig. 29 Vdc Positioner Electronics Card (Including Shutdown Module Versions)



### **All AEL7 Actuators Supplied with Shutdown Module use 24 Vdc Positioner Electronics Card**

All AEL7 actuators supplied with a Shutdown Module use the 24Vdc Positioner Electronics Card because these versions always use a 24Vdc motor to enable the super-capacitors to drive the motor to the desired end position when shut down mode is activated.

### **AEL7 Actuators Supplied with Shutdown Module are not suitable for 24 Vac power supply**

AEL7 actuators fitted with the Shutdown Module can be specified with 230Vac or 110Vac, as well as 24Vdc supply voltage. These versions are NOT available for use with a 24Vac supply voltage.

### **AEL7 Actuators Supplied with Shutdown Module are internally hard wired**

Please refer to Figure 7 (AEL72-78 Vac/Vdc Terminal Diagram with Shutdown Module) to ensure that the correct Supply Voltage is applied to the correct terminal within the shutdown module itself. The Shutdown Module is hardwired in the factory to the actuator terminals. There is NO requirement to connect any wiring to terminals within the actuator cover.

**Table 16 Operation and Parameter Setting**

<b>Push button</b>	<b>LED</b>	<b>Function</b>
PROG	Orange	Programming button / Save button
UP	Red	Movement - actuator spindle extending
DOWN	Green	Movement - actuator spindle retracting
HAND	Blue	Switchover - Manual / Auto

<b>Dip switch</b>	<b>LED</b>	<b>FUNCTION</b>
S1	N/A	Signal, seating and control configuration
S2		Tuning, calibration and shutdown
S3		Internal positioner setting mode (DO NOT TOUCH)
S4		Shutdown module release

**Table 17 DIP Switch SW.1 Configuration (24Vdc and Shutdown Module)**

DIP Switch SW.1			
Switch Nr.	Function	OFF	ON
S1.1	Setting of stroke	Off	On
S1.2	Action	Direct*	Reverse
S1.3	Potentiometer	Internal*	n/a
S1.4			
S1.5	Signal Range	4-20mA / 2-10V*	0-20mA / 0-10V
S1.6	n/a	n/a	
S1.7	Hysteresis	See Table 13	
S1.8			

**Table 18 DIP Switch SW.2 Configuration (24Vdc and Shutdown Module)**

DIP Switch SW.2			
Switch Nr.	Function	OFF	ON
S2.1	AUTOTUNE	Off	On
S2.2	n/a	n/a (set to Off)	
S2.3			
S2.4			
S2.5	Failure mode	See Table 14	
S2.6			
S2.7	Seating	See Table 15	
S2.8			

**Table 19 DIP Switch SW.3 Configuration (24Vdc and Shutdown Module)**

DIP Switch SW.1			
Switch Nr.	Function	OFF	ON
S3.1	Input Positioner Setting Mode	Off*	DO NOT SET TO ON
S3.2		Off*	

**Table 20 DIP Switch SW.4 Configuration (24Vdc and Shutdown Module)**

DIP Switch SW.1			
Switch Nr.	Function	OFF	ON
S4.1	Shutdown Module Release	When ready*	Immediately
S4.2	Shutdown Module direction of travel	Extended*	Retracted

## 6.10 AUTOTUNE – Quick Set-Up (24 Vdc excluding Shutdown Module versions)

The commissioning sequence for 24Vdc actuators excluding those supplied with a Shutdown Module is the same as stated in Section 6.7 with the following exceptions.

- S3.1 and S3.2 MUST NOT be touched. These switches MUST ALWAYS be set to OFF.
- S4.1 is used to set the release mode for the Shutdown Module. For actuators without a Shutdown Module fitted S4.1 MUST be set to ON otherwise the positioner will not operate.


## 6.11 AUTOTUNE – Quick Set-Up (All Shutdown Module versions)


The commissioning sequence for all actuators supplied with a Shutdown Module is the same as stated in Section 6.7 with the following exceptions.


- S2.7 and S2.8 MUST be set to ON before the AUTOTUNE commissioning is started.
- S3.1 and S3.2 MUST NOT be touched. These switches MUST ALWAYS be set to OFF. S3 is used to internally set the positioner electronics to operate with force switches. Internally the actuator is wired with a travel switch to prevent the actuator overrunning if the actuator is removed from the valve and the shutdown module is still live. Setting S3 to ON will result in irreparable damage to the actuator in this case.
- S4.1 MUST be set to OFF before the AUTOTUNE commissioning is started. S4.1 is used to set the release mode for the Shutdown Module. Set to the "when ready" (OFF) position prevents the Shutdown Module from operating until it is fully charged. Initial charging typically takes 3-6 minutes dependant on the size of the actuator. When charged, the LED on the Shutdown Module card will be illuminated solid green (visible through a small window).
- S4.2 must be set to the correct direction of stem movement required in the event of loss of power supply.

## 6.12 Adjustment of Actuator Stroke (8 kN+)

The physical stroke of the 8 kN+ AEL7 Series actuator can be adjusted precisely to meet the valve stroke requirements, for example when the actuator thrust could damage the valve. This is controlled by Stroke Dependent Switch S3. Increasing or decreasing the stroke will impact the resolution of the potentiometer. Ensuring that potentiometer resolution is maintained is controlled by the Stroke Arm and Stroke Slider (Figure 30).

	<b>Caution</b> Before commencement of any work to inspect, install, commission, remove or modify the actuator stroke, please read to Section 1 "Safety Information", Section 4.1 "Electrical Connection Safety Considerations" and Section 6.1 "Commissioning Safety Information".
---	---

	<b>Warning</b> Do not use the hand wheel or hand crank when either electrical power supply of control signal are applied. The actuator may respond to manual interaction resulting in muscular-skeletal damage to fingers.
---	---


	<b>Caution</b> It is possible to damage the force dependent switches by applying excessive load by use of the hand wheel or hand crank.
---	--

With the actuator spindle in the fully extended position, the power supply safely isolated and the actuator cover removed:

- Couple the actuator to the valve in line with the correct mounting flange and linkage kit (Section 3 and TI-P713-02)
- Ensure the correct thread engagement is observed (Tables 3 to 5)
- The Stroke Arm and Potentiometer Lever should be parallel (Figure 30)
- Loosen the Stroke Slider lock nut (10 mm A/F) and carefully move the slider to the required stroke as indicated on the arm (Figure 31)
- Tighten the Stroke Slider Lock nut
- Drive the actuator through the full stroke to check the stroke limits are correct

**Note:** when adjusting the stroke of the actuator, consider the setting of Stroke Dependent Switch S3. S3 must be adjusted to match or exceed the required stroke in order not to restrict valve travel.

**Note:** the stroke arm must not come in contact with the actuator base under any circumstance

	<b>Caution</b> The stroke arm must not come in contact with the actuator base under any circumstance. This can cause damage to and malfunctioning of the actuator.
---	---



When adjusting the stroke of the actuator, consider the setting of Stroke Dependent Switch S3. S3 must be adjusted to match or exceed the required stroke in order not to restrict valve travel.

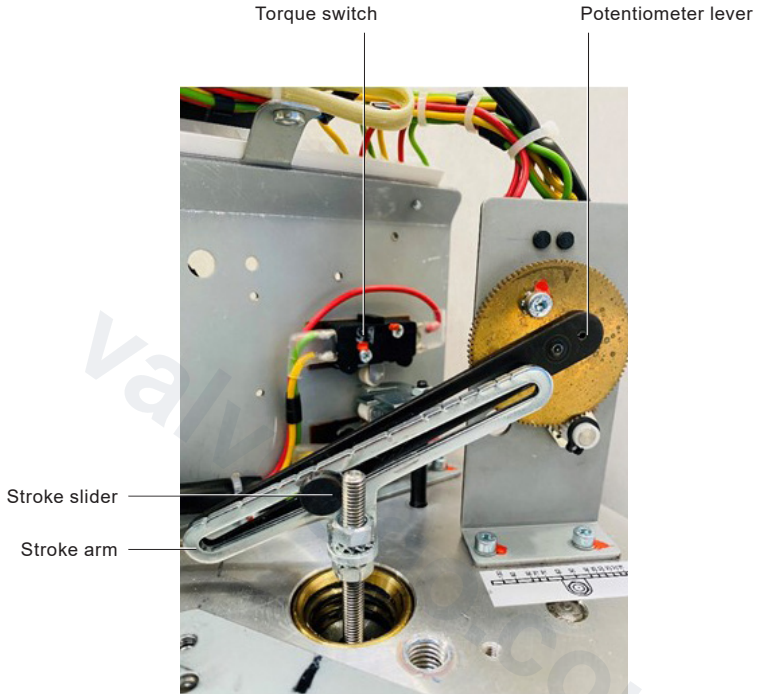


Fig. 30 8 kN+ AEL7 Stroke arm arrangement

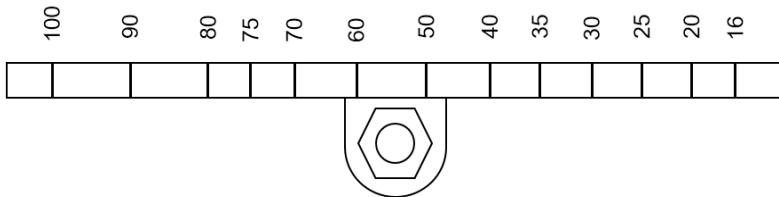


Fig. 31 AEL7 Stroke arm (8 kN+)

# 7. Maintenance

## 7.1 Maintenance Safety Information



### Caution

Before commencement of any commissioning work please read to Section 1 "Safety Information", and Section 4.1 "Electrical Connection Safety Considerations".

Always read the Safety Information Sections of the relevant Installation and Maintenance Instructions for the control valve and any accessories as well as the actuator before commencing any work.



### Warning

Always ensure that the control valve is isolated and all necessary risk assessments and method statements have been validated and authorized prior to commencing maintenance operations.

Mains connection and maintenance of the AEL7 Series actuator or control valve requires specialist knowledge of electrical circuits and systems, and the inherent dangers. A working knowledge of linear actuators and control valves is also required.

Risk of injury by moving parts. Ensure that that the control system is disabled and the electrical power supply is isolated to ensure that the valve and actuator do not move without warning.

The incorrect use of power supplies to assist the installation, commissioning and maintenance of electrically actuated valve assemblies increases the risk of personal injury.

Lifting and fitting or actuators increases the risk of personal injury

### Warning - crush hazard

When actuators are to be fitted using lifting equipment ALWAYS ensure that the actuator is carefully slung in order that it cannot fall. NEVER attempt to remove a control valve from the line by using the actuator as the lifting point. The actuator or the lifting equipment could become damaged.

Never stand under components that are being lifted. Head safety protection must always be worn when operating on or close to equipment where lifting operations are taking place.

**Do not** place hands within the actuator yoke or on the stem when isolation of the electrical power supply has been removed.

**Do not** attempt to restrict actuator stroke or movement, or increase seat load through the placing of objects within the actuator yoke. This practice could also result in the **loss of sight**

### Warning - Muscular skeletal damage

For small actuators that do not require mechanical lifting aids, always ensure that manual lifting best practice is observed. Always use two personnel where possible and ensure that proper access is available in order to ensure a secure foothold.

## 7.2 General Maintenance of Actuator

The AEL7 is a low maintenance actuator. Routine or periodic maintenance is not required under normal operational demands.

The following parts can be replaced in the event of a break-down. Please refer to the relevant section of this document for details.

- Auxiliary travel switches
- Potentiometer
- Anti-condensation heater
- Positioner card
- Valve adaptor

Elastomer sealing elements can be subject to deterioration and should be inspected at regular intervals and replaced if necessary.

## 7.3 Warranty, Repair and Spare Parts


The heavy duty AEL7 Series actuator is supplied with 36 month warranty from date of manufacture or 24 months in operation (whichever is soonest). The warranty is for the defective manufacture and assembly of the actuator. Failures as a result of poor installation of the actuator, the valve or as a result of poor system design and maintenance are outside of the scope of this warranty. Damage as a result of handling, improper repair works, negligence or chemical and electro-chemical influences are also out of the scope of any warranty consideration.

In the rare event that an actuator should fail in operation, please contact your local Spirax Sarco Sales Company for product return instructions.

The AEL7 Series actuator should not be repaired in the field. In the rare event that The AEL7 Series actuator should need to be repaired, the actuator must be returned to the factory with a full field failure report.

Spare parts for the actuator are only available when assembled by the factory in Germany. Please contact your local Spirax Sarco Sales Company for product return instructions.

# 7.4 Shutdown Module Discharge

	<b>Warning: Working with the Shutdown Module</b>
	<p>The Shutdown Module used in the AEL7 Series linear actuator contains super capacitors.</p> <ul style="list-style-type: none"><li>- Supercapacitors contain materials that can be toxic or irritant. Ensure that the area is well ventilated before removing the cover of the Shutdown Module.</li><li>- Supercapacitors can release an electric charge. Please consider the risk of electric shock when the cover is removed.</li><li>- Supercapacitors can become damaged during maintenance. Ensure that the correct Personal Protective Equipment is used including Butyl gloves and safety goggles.</li></ul> <p>The supercapacitors <b>MUST NOT</b> be removed from the Shutdown Module. If the supercapacitors need to be replaced, the actuator <b>MUST</b> be returned to the factory for repair.</p> <p>Inspect the supercapacitors for signs of damage or leaking prior to commencement of work. If any leaking or damage is present, the actuator must be replaced.</p> <p><b>The shutdown Modules must only be discharged by Spirax Sarco engineers</b></p>

The Shutdown Module should be discharged before any maintenance activity, including removal of the actuator from the valve. Failure to do so could result in the actuator moving without warning.

With the valve safely isolated from the system and the actuator safely isolated from the power supply:

- Remove the Shutdown Module cover
- Identify and disconnect the supercapacitor plug from the Shutdown Module board (Figure 32)

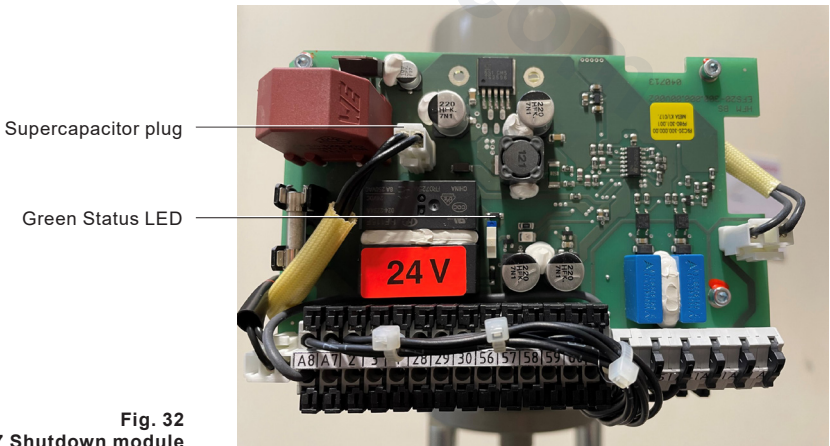


Fig. 32  
AEL7 Shutdown module



**Warning: Do Not Reinstate the Shutdown Module without performing the discharge operation**

If the supercapacitors plug is removed from a charged Shutdown Module, it **MUST NOT** be reinstated to the board without completing the discharge process. Failure to do so will result in irreparable damage to the actuator and poses a risk of harm to the operative.

- Plug the discharge cable first on to the Shutdown Module board, and then on to the corresponding positive and negative terminals of a discharge device (Kunkin KP182 DC) as shown in Figure 33.
- Check the connections and then switch the discharge device ON
- The discharging process will start.
- When Voltage is 0V, the discharging device can be disconnected and reset by pressing the "SHIFT" and "DOWN" buttons simultaneously. The status LED will also be extinguished.
- With the supercapacitors safely discharged, the supercapacitor plug can be reconnected to the main board.
- The discharging process takes approximately 2 to 7 minutes dependent upon actuator size.



Fig. 33 Discharge device

## 7.5 Removing the Actuator from the Valve



### Caution

Before commencement of any commissioning work please read to Section 1 "Safety Information", Section 4.1 "Electrical Connection Safety Considerations" and Section 7 "Maintenance Safety Information".

Sometimes it may be necessary to remove the actuator from the valve for general valve maintenance or to replace the actuator itself. With the actuator spindle in approximately the mid-stroke position, the power supply safely isolated and the actuator cover removed:

- Disconnect the power supply and control signal cable cores from the respective terminals (label for identification if not already done so)
- Loosen the cable gland nut(s) and carefully slide the power supply and control signal cables through the gland(s)
- Make safe the loose cables in case of accidental power restoration
- Manually move the valve off it's seat by 20-50% of the actuator travel
- Loosen the valve adapter and remove the anti-rotation and clamp plates
- Loosen the pillar nuts and remove the actuator from the valve

To return or replace the actuator to the valve, refer to Section 3.5 "Coupling the Actuator to a Valve".  
To commission the actuator, refer to Section 6. "Commissioning".

## 7.6 Problem Solving

Observation	Possible Cause
<b>Actuator does not move (VMD)</b>	Supply voltage interrupted
	Supply fuse blown
	Maximum operating temperature exceeded
	Motor failure
<b>Supply fuse blows</b>	Incorrectly sized fuse
	Incorrectly sized wire
	Poor cable core connection within the actuator
	Exposed cable cores within the actuator
<b>Valve does not achieve full stroke (0%)</b>	Incorrect control signal
	Actuator incorrectly coupled
	Interference within the valve
	Potentiometer incorrectly commissioned
<b>Valve does not achieve full stroke (100%)</b>	Positioner stroke incorrectly commissioned
	Incorrect control signal
	Actuator incorrectly coupled
	Interference within the valve
	Travel dependent switch restricting travel
	Potentiometer incorrectly commissioned
<b>Actuator does not respond to signal (positioner)</b>	Positioner stroke incorrectly commissioned
	Stroke arm incorrectly commissioned
	Control signal out of range (check voltage/ current)
	Positioner incorrectly commissioned
	Potentiometer failure
<b>Actuator moving continuously</b>	Maximum operating temperature exceeded
	Motor failure
	Poor PID set-up
	Motor capacitor failure

# 8. Declaration of Conformity

spiraxsarco.com

**spirax**  
**sarco** EN

## EU DECLARATION OF CONFORMITY

Apparatus model/Product: **Electric Linear Actuators:  
AEL7 Series**

Name and address of the  
manufacturer or his authorised  
representative: **Spirax Sarco Ltd,  
Runnings Road  
Cheltenham  
GL51 9NQ  
United Kingdom**

This declaration of conformity is issued under the sole responsibility of the manufacturer.

The object of the declaration described above is in conformity with the relevant Union harmonisation legislation:

2014/35/EU Low Voltage Directive  
2014/30/EU EMC Directive  
2006/42/EC Machinery Directive

References to the relevant harmonised standards used or references to the other technical specifications in relation to which conformity is declared:

(Low Voltage Directive) EN 61010-1:2010+A1:2019  
(EMC Directive) EN 61000-6-2:2005  
EN 61000-6-4:2007 + A1:2011  
(Machinery Directive) EN 60204-1:2018  
EN ISO 12100:2010

Signed for and on behalf of: **Spirax Sarco Ltd,**  
(signature):   
(name, function): **N Morris  
Compliance Manager, Steam Business Development Engineering  
Cheltenham**  
(place and date of issue): **2022-09-26**

**DECLARATION OF CONFORMITY**

Apparatus model/Product: **Electric Linear Actuators:  
AEL7 Series**

Name and address of the manufacturer or his  
authorised representative: **Spirax Sarco Ltd,**  
Runnings Road  
Cheltenham  
GL51 9NQ  
United Kingdom

This declaration of conformity is issued under the sole responsibility of the manufacturer.

The object of the declaration described above is in conformity with the relevant statutory requirements of:

**SI 2016 No.1101 \* The Electrical Equipment (Safety) Regulations 2016**

**SI 2016 No.1091 \* The Electromagnetic Compatibility Regulations 2016**

**SI 2008 No.1597 \* The Supply of Machinery (Safety) Regulations 2008**

(\*As amended by EU Exit Regulations)

References to the relevant designated standards used or references to the other technical specifications in relation to which conformity is declared:

**SI 2016 No.1101 \*** EN 61010-1:2010+A1:2019

**SI 2016 No.1091 \*** EN 61000-6-2:2005  
EN 61000-6-4:2007 + A1:2011

**SI 2008 No.1597 \*** EN 60204-1:2018  
EN ISO 12100:2010

Additional information:

Signed for and on behalf of: **Spirax Sarco Ltd,**

(signature):



(name, function): **N Morris**

**Compliance Manager  
Steam Business Development Engineering  
Cheltenham**

(place and date of issue):

**26 September 2022**

valvesgo.com