

EP6 Positioner Quick Start Guide



This guide covers only a brief description of installation and maintenance for Spiratrol and QL valves.

For detailed installation, operations, maintenance including safety, precautions, and warnings, please refer to our official instruction manual at www.spiraxsarco.com (IM-P703-02 or IM-P703-04 (ATEX)).

EP6 is Electro-Pneumatic Positioner that accurately controls valve stroke in response to an input signal of 4-20 mA from the controller.



Operators must wear ear protection when commissioning positioner

Explosion Proof Warning (Only for explosion proof type positioners)

Please ensure the unit is being used and installed in conformity with local, regional, and national explosion proof regulations.

1. Explosion proof type of cables and gaskets should be used, when explosion gases are present at the installation site. Wiring should be carried out in accordance with IEC 60364 or equivalent.
2. Power should be turned off completely when opening product's cover. When opening the cover, ensure that there is no power remaining in any electrical parts nearby.
3. Flameproof enclosure type positioner has 2 ports for power connection. Explosion proof type wires and packing should be used. Blind plug is required when any port is not being used.
4. Ring terminal with surface area of more than 1.25 mm² with M4 spring washer should be used to connect the power.
5. For external ground terminal, ring terminal with surface area of more than 5.5 mm² should be used.
6. There is risk of explosion due to static electricity charge. Static electricity charge may develop when cleaning the product with a dry cloth. It is imperative to avoid static electricity charge in the hazardous environment. If cleaning the surface of the product is needed, must use a damp cloth.
7. To meet explosion-proof marking information and ingress protection of IP66, use certified Ex-cable glands and Ex-plugs.
8. If you need additional information about the dimensions of the flameproof joints, contact Spirax Sarco directly.
9. The electric valve positioner must be connected in series with a fuse with a rated current not higher than 62 mA, a breaking capacity above 1500A, and a rated voltage not less than the working voltage of the product.
10. The cable entry must be equipped with a cable entry device, which must be an Ex cable entry device approved by the explosion-proof inspection agency (For NEPSI - according to the requirements of GB3836.1-2010 and GB3836.2-2010) and meet the requirements of the product explosion-proof mark, and the installation of the cable entry device, user must follow its instructions.

1. Installation

1.1 Linear positioner

1.1.1 Assemble the feedback pin locator and feedback pin to the actuator coupling firmly

Mounting positions	Pin locator marking	Valve stroke	MTG kit	Feedback pin locator direction
Central	N/A	20	EY3	←
		30		
		50	EY4	
		70		
Left hand side	D	20	UY3	←
	A	30		
	B or Q	50	UY1	→
	E	70		

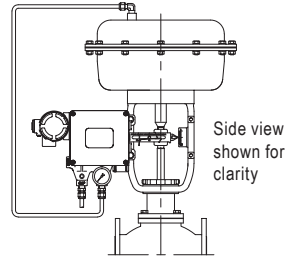

1.1.2 Assemble the supplied feedback lever, bracket and positioner firmly, then loosely mount the assembly on the left hand side of the actuator yoke. For central mount, mount on the right hand side of the actuator yoke.

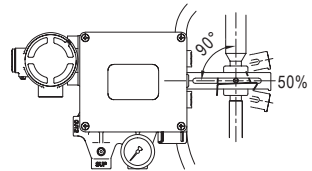

1.1.3 Make sure that Positioner's feedback lever is perpendicular to the valve stem at 50% of the valve stroke.

1.1.4 The feedback pin coming from the actuator coupling should be inserted inside slot of the feedback lever in such a way that the length of valve stroke coincides with the corresponding figures in "mm" marked on the feedback lever. Improper setting may cause poor linearity or damage to positioner.

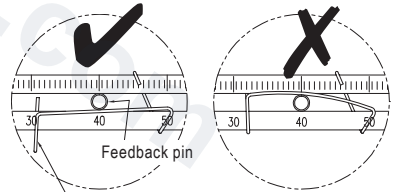

Lever spring

1.1.5 At 0% or 100% position, the linear lever or linear lever stopper should not touch the stopping bosses of positioner.

1.1.6 As a final step, tighten the bracket to the actuator yoke.

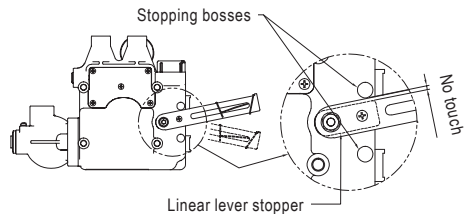
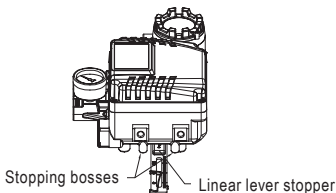

1.2 Rotary positioner

1.2.1 There are two brackets in the positioner box.

1.2.2 Refer to below and check the bolting positions of the upper and lower brackets to be fastened depending on the actuator's stem height.

And then assemble the positioner with the brackets by using M6 bolts, washers and nuts.

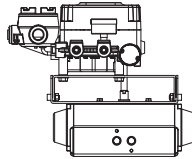

1.2.3 Make sure that the center of positioner's main shaft is well aligned with the center of actuator's stem.

1.2.4 Tighten the positioner and bracket, taking into account the alignment described in step 3 above.

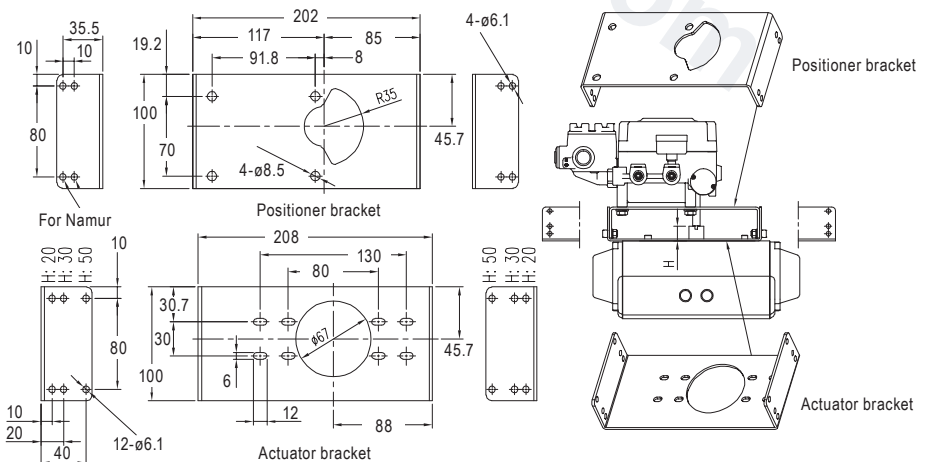
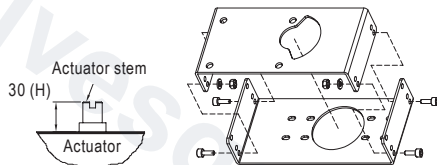

2. Connection – Air

2.1 Single acting actuator (side mount positioner)

Notes:

- The positioner must only be supplied with instrument air that is free of oil, water, and dust.
- The purity and oil content must meet the requirements of Class 3:3:2 in accordance with ISO 8573-1

2.1.1 Piping and span direction setting for linear DA single actuator

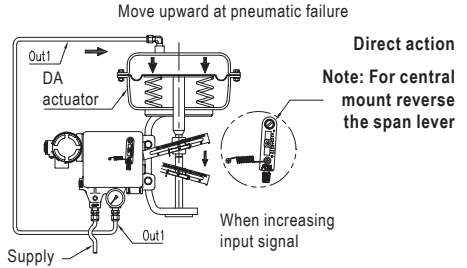
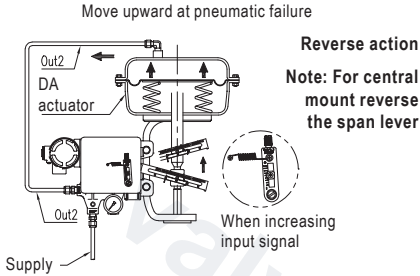

2.1.2 Piping and span direction setting for linear RA single actuator

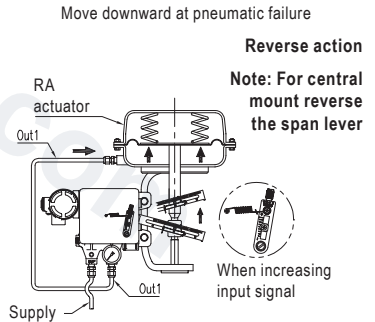
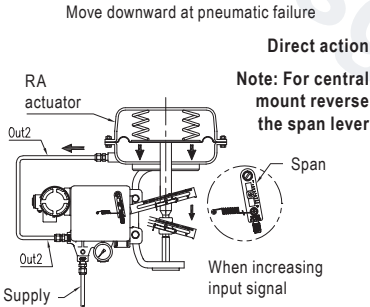

2.1.3 Piping and cam direction setting for rotary single actuator

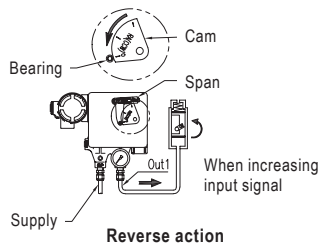
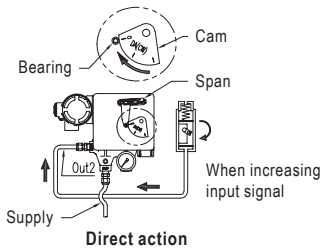

2.2 Double acting actuator (side mount positioner)

2.2.1 Piping and cam direction setting for linear double actuator

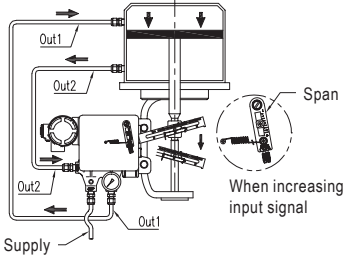

Direct action

Note: For central mount reverse the Span lever

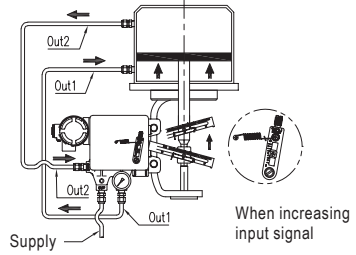

Reverse action

Note: For central mount reverse the Span lever

2.2.2 Piping and cam direction setting for rotary double actuator

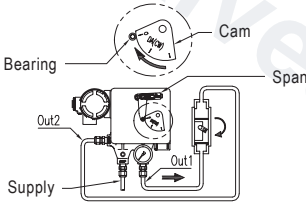

Direct action

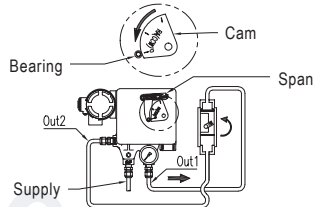

Reverse action

3. Connection – Power

It is recommended to use 4-20mA DC current source.

3.1 Flameproof enclosure type

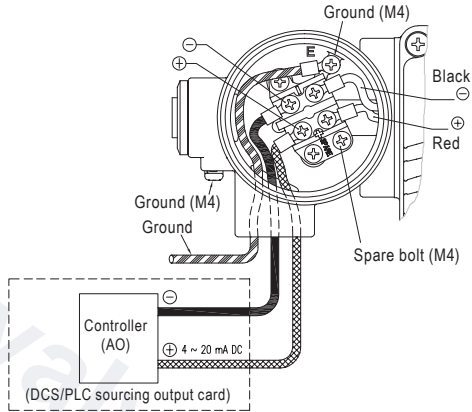

3.2 Non-explosion proof type

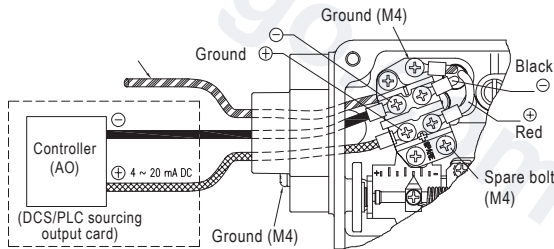

4. Adjustments



Operators must wear ear protection when commissioning positioner

4.1 Adjustment - Zero Point

Set input signal at 4mA (or 20mA) as the initial current, then rotate the adjust wheel of zero setting unit upward or downward to set actuator's zero point.

Please refer to the figure below.

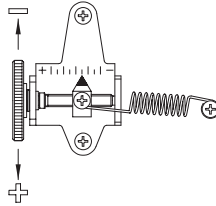

4.2 Adjustment - Span

- 4.2.1 After setting zero point, supply input signal at 20mA (or 4mA) as the end point current and check the actuator stroke. If the stroke is low, the span should be stretched. If the stroke is high, the span should be reduced.
- 4.2.2 Changing span will affect zero point setting so zero point should be set again after span has been adjusted.
- 4.2.3 Above two steps are required several times until both zero and span are properly set.
- 4.2.4 After proper setting, tighten lock screw of the span unit.

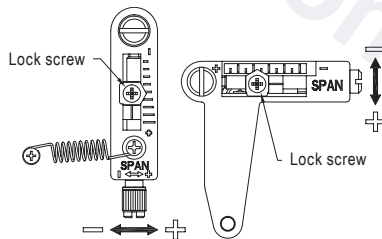

4.3 Adjustment – A/M switch (Auto/Manual)

- 4.3.1 Auto manual switch is located on the top of pilot unit. Auto manual switch allows the positioner to be functioned as by-pass. If the switch is rotated counterclockwise (toward "M", Manual), then the supply pressure will be directly supplied to the actuator through Out1 port of positioner regardless of input signal. On the other hand, if the switch is turned clockwise (toward "A", Auto), then the positioner will operate normally by input signal.
- 4.3.2 Make sure that the supply pressure does not exceed the rated pressure level of the actuator before the switch is loosened toward "M".
- 4.3.3 After using the "Manual" function, return the auto manual switch to "Auto".

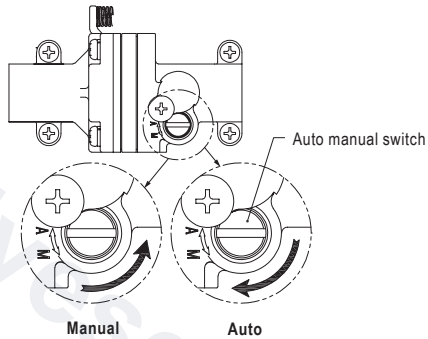

5. Approvals

spiraxsarco.com

spirax
sarco EN

EU DECLARATION OF CONFORMITY

Apparatus model/Product: **Explosion Proof, Electro-pneumatic Positioner
EP6**

Name and address of the manufacturer or his
authorised representative: **Spirax Sarco Ltd,**
Runnings Road
Cheltenham
GL51 9NQ
United Kingdom

This declaration of conformity is issued under the sole responsibility of the manufacturer.

The object of the declaration described above is in conformity with the relevant Union harmonisation legislation:

2014/30/EU EMC Directive
2014/34/EU ATEX Directive

References to the relevant harmonised standards used or references to the other technical specifications in relation to which conformity is declared:

EMC Directive EN 61000-6-4:2007 + A1:2011
EN 61000-6-2:2019
ATEX Directive EN IEC 60079-0:2018
EN 60079-1:2014
EN 60079-18:2015 + A1:2017

Where applicable, the notified body:

Notified Body	number	Performed	Certificate
Element Materials Technology Rotterdam B.V. Voorerf 18, 4824 GN Breda Netherlands	2812	Issue of Quality Assurance Notification	TRAC13QAN0002
Beureau Veritas Consumer Products Services Germany GmbH, Oehleckerring 40, Hamburg D-22419	2004	Issue of EC Type examination certificate	EPS21ATEX 1 035X

Additional information:

ATEX coding:  II 2G Ex db mb IIB T5 Gb
Ta= -20°C to +60°C

Signed for and on behalf of: Spirax Sarco Ltd,

(signature): 

(name, function): N Morris
Compliance Manager
Steam Business Development Engineering

(place and date of issue): Cheltenham
2022-05-13

GNP234-EU-C/01 issue 4 (EN)

Page 1/25

DECLARATION OF CONFORMITY

Apparatus model/Product: **Explosion Proof, Electro-pneumatic Positioner EP6**

Name and address of the manufacturer or his authorised representative: **Spirax Sarco Ltd,**
 Runnings Road
 Cheltenham
 GL51 9NQ
 United Kingdom

This declaration of conformity is issued under the sole responsibility of the manufacturer.

The object of the declaration described above is in conformity with the relevant statutory requirements of:

SI 2016 No.1091 * The Electromagnetic Compatibility Regulations 2016

SI 2016 No.1107 * The Equipment and Protective Systems Intended for Use in Potentially Explosive Atmospheres Regulations 2016

(*As amended by EU Exit Regulations)

References to the relevant designated standards used or references to the other technical specifications in relation to which conformity is declared:

SI 2016 No.1091 * EN 61000-6-4:2007 + A1:2011
 EN 61000-6-2:2019

SI 2016 No.1107 * EN IEC 60079-0:2018
 EN 60079-1:2014
 EN 60079-18:2015 + A1:2017

Where applicable, the approved body:

Approved Body	number	Performed	Certificate
Eurofins E&E CML Limited	2503	Issue of UK Type examination certificate	CML21UKEX1821X
Element Materials Technology Warwick Ltd.	0891	Issue of Quality Assurance Notification	EMA21UKQAN0002

Additional information:

Ex coding:  II 2G Ex db mb IIB T5 Gb
 Ta= -20°C to +60°C

Signed for and on behalf of: Spirax Sarco Ltd,

(signature): 

(name, function): N Morris
 Compliance Manager
 Steam Business Development Engineering

(place and date of issue): Cheltenham

15 July 2022

GNP234-UK-C/01 issue 1

Page 1 of 1