

Gaugeable Tube Fittings and Adapter Fittings



- Available in tube sizes from 1/16 to 2 in. and 2 to 50 mm
- Consistent gaugeability upon initial installation
- Easy to disconnect and retighten
- Wide variety of materials and configurations
- Demonstrated reliability and performance

Features

- Live-loaded, two-ferrule design.
- Easy to install.
- No torque is transmitted to tubing during installation.
- Swagelok® gap inspection gauge ensures sufficient pull-up upon initial installation.

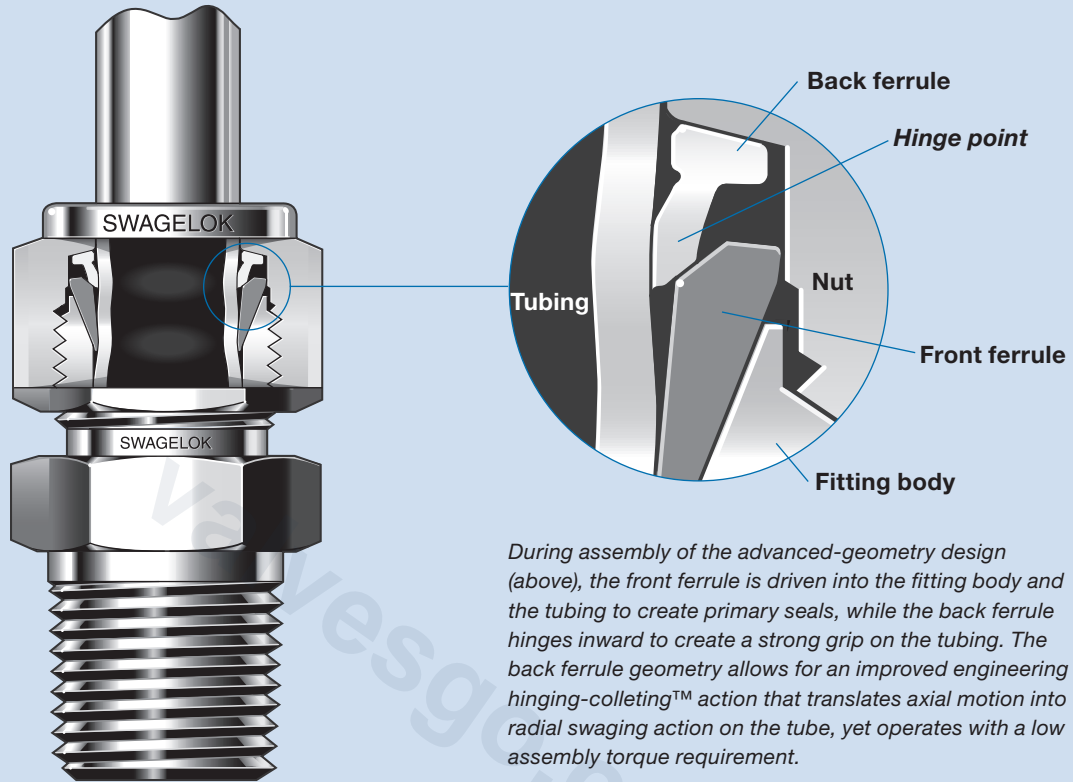

During assembly of the advanced-geometry design (above), the front ferrule is driven into the fitting body and the tubing to create primary seals, while the back ferrule hinges inward to create a strong grip on the tubing. The back ferrule geometry allows for an improved engineering hinging-colletting™ action that translates axial motion into radial swaging action on the tube, yet operates with a low assembly torque requirement.

Two-Ferrule, Mechanical Grip Design

The two ferrules separate sealing and tube gripping functions; each ferrule is optimized for its function.

The front ferrule creates a seal:

- against the fitting body
- on the tubing outside diameter.

As the nut is turned, the back ferrule:

- axially advances the front ferrule
- radially applies an effective tube grip.

Advanced-Geometry, Hinging-Colletting Back Ferrule Design

This design is standard on all 1/4 to 1 in. and 6 to 25 mm Swagelok stainless steel tube fittings to help installers make more consistent, leak-tight tube connections.

In these sizes, a patented case hardening process and patented recessed and contoured geometry provide a unique engineered advantage to the Swagelok back ferrule, providing:

- excellent gas-tight sealing and tube-gripping action
- easily achieved proper installation
- consistent remakes
- excellent vibration fatigue resistance and tube support
- full compatibility with original Swagelok stainless steel tube fittings of identical sizes.

Refer to *316 Stainless Steel Swagelok Tube Fittings with Advanced Geometry Back Ferrules* technical report, [MS-06-16](#), for additional information.

Contents

Features, 2

The Swagelok Tube Fitting Advantage, 6

Compliance with Industry Standards, 7

Materials, 8

O-Rings, 8

Cleaning and Packaging, 8

Metric Swagelok Tube Fittings, 9

Pressure Rating Basis and Thread Specifications, 9

Pressure Ratings, 10

Ordering Numbers and Dimensions, 14

Additional Products

- For Alloy 2507 super duplex tube fittings, refer to *Gaugeable Alloy 2507 Super Duplex Tube Fittings* catalog, [MS-01-174](#).
- For alloy 400 tube fittings, refer to *Gaugeable Alloy 400 Mechanically Attached Pipe and Tube Fittings* catalog, [MS-02-332](#).
- For PFA tube fittings, refer to *PFA Tube Fittings* catalog, [MS-01-05](#).
- For medium- and high-pressure tube fittings, refer to *Medium- and High-Pressure Fittings, Tubing, Valves, and Accessories* catalog, [MS-02-472](#).

Straight Fittings

Unions



Union, 14

Reducing Union, 15



Bulkhead Union and Bulkhead Reducing Union, 16

Male Connectors



NPT, 17

ISO/BSP Tapered Thread (RT), 18

ISO/BSP Parallel Thread (RS), 19

ISO/BSP Parallel Thread (RP), 20



Bulkhead NPT, 21



SAE/MS Straight Thread (ST) and Long SAE/MS Straight Thread (ST), 21



O-Seal (SAE/MS Straight Thread and NPT), 22



AN and AN Bulkhead Fitting, 23



10-32 Thread, M5 × 0.8 Thread, and Metric Thread (RS), 24

Weld Connectors



Tube Socket, 24

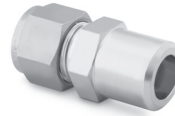

Male Pipe, 25

Female Connectors



NPT, 26

ISO/BSP Tapered Thread (RT), ISO/BSP Parallel Thread (RJ and RP), 27

ISO/BSP Parallel Thread (RG, Gauge), 28

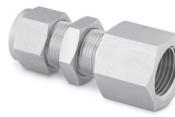

Bulkhead NPT, 28

Reducers



Reducer, 29

Long Reducer, 30



Bulkhead Reducer, 30

Port Connectors



Port Connector and Reducing Port Connector, 31

Contents

Caps and Plugs



Cap, 32



Plug, 32

Vent Protectors



Mud Dauber, 32

90° Elbows

Unions



Union, 33

Male



NPT, 34

ISO/BSP Tapered Thread (RT), 35



Reducing Elbow, 36



Positionable, ISO/BSP Parallel Thread (PR) and Positionable, SAE/MS Straight Thread (ST), 37

Weld



Tube Socket, 38



Male Pipe, 38

Female



NPT, 38

45° Elbows

Male



NPT, 39



Positionable, SAE/MS Straight Thread (ST), 39

Tees

Unions



Union and Reducing Union, 40

Male



Branch, NPT (TTM) and Adapter Tees, 42



Run, NPT (TMT), 43



Positionable Branch, SAE/MS Straight Thread (TTS) and Positionable Branch, ISO/BSP Parallel Thread (TTR), 44



Positionable Run, SAE/MS Straight Thread (TST), 44



Positionable Run, ISO/BSP Parallel Thread (TRT), 45

Female



Run, NPT (TFT), 45



Branch, NPT (TTF), 46

Cross



Union, 46

Application-Specific Fittings

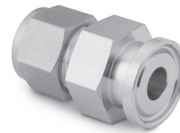

Kwik-Clamp Flange to Swagelok Tube Fitting, 47



Orifice Plate Fitting, 48

Bored-Through Fittings

For thermocouples, dip tubes, and heat exchanger tees, 20

Tube Adapters

Tube Adapter Information, 49

Male



NPT and ISO/BSP Tapered Thread (RT), 50

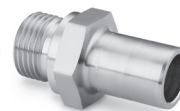

ISO/BSP Parallel Thread (RS and RP), 51



SAE/MS Straight Thread (ST) and O-Seal (SAE/MS Straight Thread), 52



AN Thread, 52



Pipe Weld, 53

Contents

Female



NPT and ISO/BSP Tapered Thread (RT), 53

ISO/BSP Parallel Thread (RP and RJ), and ISO/BSP Parallel Thread (RG, Gauge), 54

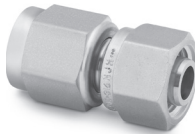

AN Thread, 54

Additional Ordering Information, 55

Replacement Parts

Nuts



Female, 57



Knurled Female, 57



Male, 57

Ferrules



Front, 58



Back, 58

Nut-Ferrule Set and Package and Ferrule Set and Ferrule-Pak™ Package, 59

ISO/BSP Parallel Gaskets



Steel (RS Fitting), Copper (RP Fitting), Copper (RG, Gauge Fitting), and PTFE (RJ Fitting), 60



O-Rings

Buna N (O-Seal Straight Threads and O-Seal Pipe Threads) and Fluorocarbon FKM (ISO/BSP Parallel Threads and SAE/MS Straight Threads), 61

Tools and Accessories

Hydraulic Swaging Units, 62



Preswaging Tools, 65



Wrenches, 66



Gap Inspection Gauges and Depth Marking Tools, 67



Bulkhead Retainers, 68



Inserts for Soft Plastic Tubing, 68

For liquid leak detectors, lubricants, and sealants, refer to *Leak Detectors, Lubricants, and Sealants* catalog, MS-01-91.

For tube benders and tube preparation tools, refer to *Tubing Tools and Accessories* catalog, MS-01-179.

Gaugeability, 69

Installation Instructions, 69

Swagelok Tube Fittings, 70

O-Seal Male Connectors, 70

Caps and Plugs, 71

Port Connectors, 71

Positionable Elbows and Tees, 72

Tube Adapters, 72

AN Thread Swivel Nut, 72

Weld Fittings, 73

Depth Marking Tool, 73

Non-Gaugeable Preswaging Tool, 73

Tools Required for Gaugeable Preswaging Tool Instructions, 74

Gaugeable Preswaging Tool Instructions, 74

Gaugeable Preswaging Tool, Tube Fitting Installation, 75

Gaugeability, 75

Chromatograph Fittings



Refer to *Gaugeable Chromatograph and Column End Fittings* catalog, MS-02-173.

Dielectric Fittings



Refer to *Dielectric Fittings* catalog, MS-02-36-SCS.

Flanges



For ANSI, DIN, and JIS flanges, refer to *Flange Adapters* catalog, MS-02-200.

VCO® and VCR® Face Seal Fittings



Refer to *VCR Metal Gasket Face Seal Fittings* catalog, MS-01-24 and *VCO O-Rings Face Seal Fittings* catalog, MS-01-28.

The Swagelok Tube Fitting Advantage

“Over 10 000 fittings and not a single leak.”

Messages from customers credit Swagelok components and tube fittings, along with Swagelok distributor support, as having played a major role in helping them succeed.

Swagelok continues to improve the performance and reliability of the tube fitting for use in thousands of diverse applications—including research, alternative fuels, analytical and process instrumentation, oil and gas, power, petrochemical, and semiconductor industries—and addressing such critical issues as:

- gas-tight seal
- vibration (tube grip)
- thermal shock
- compliance with industry standards
- installation
- corrosion
- intermix/interchange.

Gas-tight Seal

Excellent sealing and consistent reassembly help ensure accurate measurements of process parameters—air, steam, fuel, and water—to keep your plant operating efficiently. Moreover, Swagelok tube fittings minimize fugitive emissions, as well as process fluid leakage and operation costs.

Contact your authorized Swagelok sales and service representative for more information about Swagelok Energy Emissions Surveys or to schedule a survey.



Vibration (Tube Grip)

The patented case-hardening process and back-ferrule geometry provide excellent vibration fatigue resistance and tube support—even in harsh or stressful environments, such as hydrocarbon processing, on-vehicle applications, or rotary equipment applications.

Swagelok has conducted vibration tests, which show that the Swagelok tube fitting with advanced geometry hinging-colleting back ferrule isolates and protects the stress riser that is generated along the tube during the gripping part of assembly. The colleting portion of the back ferrule allows more material to contact the tube, for additional support. This colleting action enhances gripping performance and provides both direct and axial support to the gripping function. This design

minimizes the effects of bending deflection at the point of grip on the tubing.

Contact your authorized Swagelok representative for more information about vibration test reports.

“Used exclusively on our equipment and has proven to be very reliable and easy to maintain.”



“I have used Swagelok fittings from when I was a technician through today in my role in facility management. Would recommend them for any use.”

Thermal Shock

The elastic, live-loaded two-ferrule design compensates for changes in temperature during system start-up and shutdown and helps eliminate leakage related to rapid thermal expansion or contraction.

Swagelok has conducted tests that demonstrated the capability of Swagelok tube fittings to withstand thermal shock and high temperature.

Contact your authorized Swagelok representative for more information about thermal shock test reports.

Compliance with Industry Standards

Swagelok Company works with standards organizations around the world to provide you with products that address your needs.

Stainless steel Swagelok tube fittings used with 316 stainless steel and 316 Ti stainless steel alloy tubing as shown in the table have been tested to the requirements of ECE R110. In addition, stainless steel Swagelok tube fittings are available with EC-79 certification.

Tube OD	Wall Thickness
3 to 16 mm	0.7 to 2.5 mm
1/8 to 5/8 in.	0.028 to 0.095 in.

NACE - Sour Gas

Swagelok offers fittings in materials that meet the metallurgical requirements of NACE MR0175/ISO 15156 and MR0103. Refer to *NACE MR0175/ISO 15156 Compliant Swagelok Fittings*, [MS-06-124](#), for additional information.

NORSOK

Fittings manufactured from alloy 2507 and 6MO are NORSOK M-630 and M-650 compliant as standard. Contact your authorized sales and service representative for additional details.



Third-Party Agencies

- Vd TÜV
- TÜV SUD Automotive
- DVGW
- Department of the Navy (U.S.)
- Det Norske Veritas (DNV)
- Nippon Kaiji Kyokai (NK)
- American Bureau of Shipping (ABS)
- Lloyd's Register of Shipping (LR)
- Bureau Veritas (BV)
- RS Maritime
- Canadian Provincial Agencies (CRN)
- Russian GOST TR (Customs Union Countries)
- UkSepro for Ukraine
- Inspecta Nuclear for Sweden
- METI/KHK
- Engineers India Limited (EIL)

For a complete listing, refer to the *Tube Fitting Performance Product Test Reports PTRs and Third-Party Product Approvals and Registrations*, [MS-06-108](#).

See **Materials**, page 8; **Thread Specifications**, page 9; and **Pressure Ratings**, page 9, for more information about the specifications to which Swagelok tube fittings are manufactured.

Contact your authorized Swagelok representative for more information about Swagelok tube fitting certifications.

Installation

The Swagelok tube fitting installation advantages:

- Easy to install
- No torque is transmitted to tubing during installation
- Swagelok gap inspection gauge assures sufficient pull-up upon initial installation.

Swagelok tube fitting components provide exceptional dimensional,

metallurgical, and mechanical uniformity that allow predictable, repeatable installation.

Swagelok authorized sales and service centers offer installation training seminars that provide additional information on:

- The requirements for making safe, leak-tight connections
- A variety of tools and accessories designed for use with Swagelok tube fittings.

Corrosion

Swagelok tube fittings are available in a variety of materials, including optimized 316 stainless steel chemistry with elevated nickel, chromium, and other elements for superior corrosion resistance in a variety of applications, including chemical processing, sour gas and subsea systems.

Swagelok has conducted tests in accordance with ASTM B117-95 to evaluate the corrosion resistance of Swagelok tube fittings.

Contact your authorized Swagelok representative for more information about corrosion resistance test reports.

Intermix/Interchange

Swagelok recommends NO intermix/interchange of Swagelok tube fitting components with other manufacturers' components.

- No industrial design standard exists for two ferrule tube fittings. Each company makes components to its own design and not to any recognized standards.
- Interchanging and intermixing tube fitting components can result in unpredictable performance, environmental releases, increased costs, and can be dangerous in critical applications.

Materials

Materials Standards

Material ^⑦	Bar Stock ^①	Forgings ^②
316 stainless steel	ASTM A276, ASTM A479, ASME SA479, EN 1.4401	ASTM A182, ASME SA182, EN 1.4401
6-Moly	ASTM A479	ASTM A182
Alloy 400	ASTM B164	ASTM B564, ASME SB564
Alloy 600	ASTM B166, ASME SB166	ASTM B564, ASME SB564
Alloy 625	ASTM B446 ^③	ASTM B564, ASME SB564 ^④
Alloy 825	ASTM B425	ASTM B564, ASME SB564
Alloy C-276	ASTM B574	ASTM B564
Aluminum	ASTM B211	ASTM B247
Brass	ASTM B16, ASTM B453	ASTM B283
Carbon steel	ASTM A108	—
PFA ^⑤	—	ASTM D3307 Type I
PTFE	ASTM D1710	ASTM D3294
Alloy 2507 ^⑥	ASTM A479	ASTM A182
Titanium (grade 4)	ASTM B348	ASTM B381

① Straight fittings and tube adapters.

② Elbows, crosses, and tees.

③ All straight fittings and tube adapters and 1/4 and 3/8 in.; 6 and 10 mm elbows, crosses, and tees.

④ Elbows, crosses, and tees larger than 3/8 in. and 10 mm.

⑤ Refer to *PFA Tube Fittings* catalog, [MS-01-05](#).

⑥ Refer to *Gaugeable Alloy 2507 Super Duplex Tube Fittings* catalog, [MS-01-174](#).

⑦ Contact your authorized Swagelok representative for materials not listed.

Additional Processing

Fitting bodies are processed for improved performance, as listed below. No additional processing is required for alloy 625, alloy 825, brass, 316 stainless steel, and PTFE materials.

Fitting Body Material	Process
Aluminum	Anodized, hydrocarbon film
Alloy 400, alloy C-276, alloy 600	Hydrocarbon film
Carbon steel (except weld bodies)	Zinc plating
Carbon steel (weld bodies)	Hydrocarbon film chemical conversion coating
Titanium	Anodized

■ Over 1 in./25 mm fittings are supplied with a package of fluorinated-base with PTFE and tungsten disulfide lubricant for use in fitting assembly.

■ Over 1 in./25 mm stainless steel fittings use stainless steel ferrules with PFA coating. Applications above 450°F (232°C) **require** silver-plated front ferrules and uncoated back ferrules. To order fittings with silver-plated front ferrules and uncoated back ferrules, add **BM** to the fitting ordering number.

Example: SS-2400-6**BM**

■ All carbon steel Swagelok tube fittings are supplied with 316 stainless steel back ferrules.

O-Rings

O-seal fittings include a 70 durometer Buna N O-ring. Other straight-thread fittings with O-rings include a 90 durometer fluorocarbon FKM O-ring. Other O-ring materials are available upon request. O-rings are coated with a thin film of silicone-based lubricant. Removal of factory-applied lubricants may alter performance.

For ST and ST positionable fittings used in ECE-R110 applications, add the **DE** O-ring suffix to the ordering number. Example: SS-600-1-6**STDE**

Cleaning and Packaging

Fitting components are cleaned to remove machine oil, grease, and loose particles. For more information, see Swagelok *Standard Cleaning and Packaging (SC-10)* catalog, [MS-06-62](#).

Fittings are available individually bagged; add **CP** to the ordering number. Example: SS-200-6**CP**

On request, fittings can be specially cleaned and packaged. Cleaning and packaging options can be found in *Special Cleaning of Swagelok Tube Fittings*, SCS-00663. Contact your authorized Swagelok representative for details.

Fittings cleaned and packaged in accordance with ASTM G93 Level C, will have the front ferrule silver-plated and Krytox® 240 AC applied to the internal surface of the nut. To order, add **BQ** to the ordering number.

Example: SS-400-1-4**BQ**

Oxygen Service Hazards

For more information about hazards and risks of oxygen-enriched systems, see the Swagelok *Oxygen System Safety* technical report catalog, [MS-06-13](#).

Metric Swagelok Tube Fittings

Metric tube fittings have a stepped shoulder on the body hex. Shaped fittings, such as elbows, crosses, and tees, are stamped MM for metric tubing and have no step on the forging.

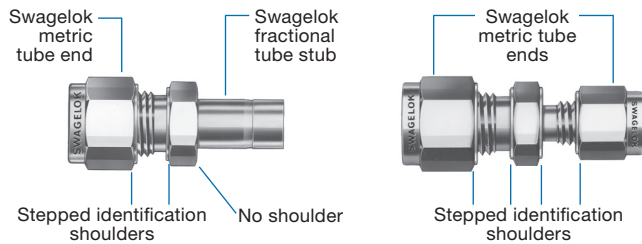

Pipe Thread Sealants

A thread sealant should always be used when assembling tapered threads. SWAK™ anaerobic pipe thread sealant and Swagelok PTFE tape are available. Refer to *Leak Detectors, Lubricants, and Sealants* catalog, [MS-01-91](#), for additional information.

Port Connectors, Reducers, and Tube Adapters

Swagelok tube adapters with the machined groove are rated to the highest suggested allowable working pressure, see Swagelok *Tubing Data*, [MS-01-107](#) for a tube outside diameter and material in question.

Pressure Rating Basis and Thread Specifications

Thread Type (End Connection)	Pressure Rating Basis	Thread Type	Reference Specification
Swagelok Tube Fittings	Swagelok tube fitting ends are rated to the working pressure of tubing as listed in Swagelok Tubing Data, MS-01-107 . Careful selection of high-quality tubing is important when installing safe, leak-tight systems.	Unified Inch Screw Threads	ASME B1.1
NPT	ASME B31.3, Process Piping or pressure testing with a 4:1 design factor based on hydraulic fluid leakage.	NPT	ASME B1.20.1, SAE AS71051
ISO/BSP (tapered) (Swagelok RT fittings)	ASME B31.3, Process Piping or pressure testing with a 4:1 design factor based on hydraulic fluid leakage.	ISO/BSP (tapered) Swagelok RT fittings	ISO 7, BS EN 10226-1, JIS B0203
ISO/BSP (parallel) (Swagelok RS fittings)	ISO 1179-3, ISO 228-1 Threads with Light-Duty Stud Ends with Sealing by O-ring with Retaining Ring (types G and H) or pressure testing with a 4:1 design factor based on hydraulic fluid leakage.	ISO/BSP (parallel) Swagelok RP and RS fittings	ISO 228, JIS B0202
ISO/BSP (parallel) (Swagelok RP fittings)	ISO 1179-1, ISO 1179-4, and ISO 228-1 Threads with Stud Ends for general use only with metal-to-metal sealing (type B) or pressure testing with a 4:1 design factor based on hydraulic fluid leakage.	ISO/BSP (parallel) Swagelok RP and RS fittings	ISO 228, JIS B0202
ISO/BSP (gauge) (Based on EN 837-1 and 837-3) (Swagelok RG and RJ fittings)	ASME B31.3, Process Piping or pressure testing with a 4:1 design factor based on hydraulic fluid leakage.	ISO/BSP (parallel) Swagelok RG and RJ fittings	ISO 228, JIS B0202
SAE-Light Duty (Swagelok ST fittings)	SAE J1926/3, Connections for General Use and Fluid Power-Ports and Stud Ends with ASME B1.1 Threads and O-ring Sealing-Part 3: Light-Duty (L-Series) Stud Ends or pressure testing with a 4:1 design factor based on hydraulic fluid leakage.	Unified Inch Screw Threads Swagelok ST fittings	ASME B1.1
SAE-Heavy Duty (Swagelok STH fittings)	SAE J1926/2, Connections for General Use and Fluid Power-Ports and Stud Ends with ASME B1.1 Threads and O-ring Sealing-Part 2: Heavy-Duty (S-Series) or pressure testing with a 4:1 design factor based on hydraulic fluid leakage.	Unified Inch Screw Threads Swagelok ST fittings	ASME B1.1
Swagelok AN fittings	SAE J514, Hydraulic Tube Fittings or pressure testing with a 4:1 design factor based on hydraulic fluid leakage.	Unified Inch Screw Threads Swagelok AN fittings	ASME B1.1 UNJ, SAE AS 8879

Pressure Ratings

NPT/ISO Pipe Pressure Ratings

Ratings are based on ASME Code for Pressure Piping B31.3, Process Piping, at ambient temperature.

NPT/ISO Pipe Size in.	316 SS, Carbon Steel, Alloy (600, and C-276)		Brass and Aluminum		Alloy 400		Titanium		Alloy 2507 and Alloy 625		6-Moly		Alloy 825	
	Male	Female	Male	Female	Male	Female	Male	Female	Male	Female	Male	Female	Male	Female
	psig (bar)	psig (bar)	psig (bar)	psig (bar)	psig (bar)	psig (bar)	psig (bar)	psig (bar)	psig (bar)	psig (bar)	psig (bar)	psig (bar)	psig (bar)	psig (bar)
1/16	11 000 (757)	6 700 (461)	5 500 (378)	3 300 (227)	9 900 (682)	6 000 (413)	8 800 (606)	5 300 (365)	15 000 (1 033)	12 900 (888)	14 900 (1 026)	9 000 (620)	12 800 (881)	7800 (537)
1/8	10 000 (689)	6 500 (447)	5 000 (344)	3 200 (220)	9 000 (620)	5 800 (399)	8 000 (551)	5 200 (358)	15 000 (1 033)	12 500 (861)	13 500 (930)	8 800 (606)	11 600 (799)	7500 (516)
1/4	8 000 (551)	6 600 (454)	4 000 (275)	3 300 (227)	7 200 (496)	5 900 (406)	6 400 (440)	5 200 (358)	15 000 (1 033)	12 700 (875)	10 800 (744)	8 900 (613)	9 300 (640)	7600 (523)
3/8	7 800 (537)	5 300 (365)	3 900 (268)	2 600 (179)	7 000 (482)	4 700 (323)	6 200 (427)	4 200 (289)	15 000 (1 033)	10 200 (702)	10 500 (723)	7 100 (489)	9 000 (620)	6100 (420)
1/2	7 700 (530)	4 900 (337)	3 800 (261)	2 400 (165)	6 900 (475)	4 400 (303)	6 100 (420)	3 900 (268)	14 800 (1 019)	9 400 (647)	10 400 (716)	6 600 (454)	8 900 (613)	5700 (392)
3/4	7 300 (502)	4 600 (316)	3 600 (248)	2 300 (158)	6 500 (447)	4 100 (282)	5 800 (399)	3 600 (248)	10 000 (689)	8 900 (613)	9 800 (675)	6 200 (427)	8 500 (585)	5300 (365)
1	5 300 (365)	4 400 (303)	2 600 (179)	2 200 (151)	4 700 (323)	3 900 (268)	4 200 (289)	3 500 (241)	10 000 (689)	8 500 (585)	7 100 (489)	5 900 (406)	6 100 (420)	5100 (351)
1 1/4	6 000 (413)	5 000 (344)	3 000 (206)	2 500 (172)	5 400 (372)	4 500 (310)	4 800 (330)	4 000 (275)	10 000 (689)	9 600 (661)	8 100 (558)	6 700 (461)	6 900 (475)	5800 (399)
1 1/2	5 000 (344)	4 600 (316)	2 500 (172)	2 300 (158)	4 500 (310)	4 100 (282)	4 000 (275)	3 600 (248)	9 600 (661)	8 900 (613)	6 700 (461)	6 200 (427)	5 800 (399)	5300 (365)
2	3 900 (268)	3 900 (268)	1 900 (130)	1 900 (130)	3 500 (241)	3 500 (241)	3 100 (213)	3 100 (213)	7 500 (516)	7 500 (516)	5 200 (358)	5 200 (358)	4 500 (310)	4500 (310)

- To determine pressure ratings in accordance with ASME B31.1, Power Piping:
 - carbon steel material—multiply by 0.85.
 Stainless steel and brass material ratings remain the same.
- To determine MPa, multiply bar by 0.10.
- On request, 1 in. and smaller NPT/ISO pipe ends can have a 10,000 psi (689 bar) pressure rating. Higher pressure ordering options can be found in *10,000 psi Tapered Threads on Swagelok Tube Fittings*, SCS-00278.

Pressure Ratings

STH SAE/MS Heavy Duty Pressure Ratings

Pressure ratings are based on SAE J1926/2 at ambient temperature.

STH SAE/MS Thread Size	Designator	316 SS, Carbon Steel, and Alloy (C-276, 2507, 625, 6-Moly, 825, and 600)		Brass and Aluminum		Alloy 400		Titanium	
		Non-positionable	Positionable	Non-positionable	Positionable	Non-positionable	Positionable	Non-positionable	Positionable
		psig (bar)	psig (bar)	psig (bar)	psig (bar)	psig (bar)	psig (bar)	psig (bar)	psig (bar)
3/8-24	3STH	9137 (630)	6091 (420)	4568 (315)	3045 (210)	8223 (567)	5482 (378)	7309 (504)	4873 (336)
7/16-20	4STH								
1/2-20	5STH								
9/16-18	6STH								
3/4-16	8STH								
7/8-14	10STH								
1 1/16-12	12STH	6091 (420)	5076 (350)	3045 (210)	2538 (175)	5482 (378)	4568 (315)	4873 (336)	4061 (280)
1 3/16-12	14STH								
1 5/16-12	16STH								
1 5/8-12	20STH	4061 (280)	4061 (280)	2030 (140)	2030 (140)	3654 (252)	3654 (252)	3248 (224)	3248 (224)
1 7/8-12	24STH		3045 (210)						1522 (105)
2 1/2-12	32STH	3045 (210)	2538 (175)	1522 (105)	1261 (87)	2741 (189)	2277 (157)	2436 (168)	2030 (140)

SAE/MS Fittings Pressure Ratings

Pressure ratings are based on SAE J1926/3 at ambient temperature.

SAE/MS Thread Size	Designator	316 SS, Carbon Steel, and Alloy (C-276, 2507, 625, 6-Moly, 825, and 600)		Brass and Aluminum		Alloy 400		Titanium		
		Non-positionable	Positionable	Non-positionable	Positionable	Non-positionable	Positionable	Non-positionable	Positionable	
		psig (bar)	psig (bar)	psig (bar)	psig (bar)	psig (bar)	psig (bar)	psig (bar)	psig (bar)	
5/16-24	2ST	5076 (350)	5076 (350)	2538 (175)	2538 (175)	4568 (315)	4104 (283)	4061 (280)	4061 (280)	
3/8-24	3ST									4568 (315)
7/16-20	4ST									
1/2-20	5ST									
9/16-18	6ST		4061 (280)		2030 (140)				3654 (252)	3654 (252)
3/4-16	8ST	4568 (315)	2175 (150)	4104 (283)	3654 (252)	3654 (252)	3248 (224)			
7/8-14	10ST	3625 (250)	3045 (210)	1740 (120)	1522 (105)	3263 (225)	2741 (189)	2900 (200)	2436 (168)	
1 1/16-12	12ST	3045 (210)	2538 (175)	1450 (100)	1261 (87)	2741 (189)	2277 (157)	2436 (168)	2030 (140)	
1 3/16-12	14ST									
1 5/16-12	16ST									
1 5/8-12	20ST	2538 (175)	2030 (140)	1160 (80)	1015 (70)	2277 (157)	1827 (126)	2030 (140)	1624 (112)	
1 7/8-12	24ST									
2 1/2-12	32ST	2030 (140)	1522 (105)	1015 (70)	754 (52)	1827 (126)	1363 (94)	1624 (112)	1218 (84)	

Pressure Ratings

Male AN (JIC) Fittings Pressure Ratings

Pressure ratings are at ambient temperature and apply to slide-on and crimped-on swivel nuts with a female gland.

Male AN (JIC) Thread Size	Designator	316 SS and Alloy (C-276, 2507, 625, 6-Moly, 825, and 600)		Carbon Steel		Brass and Aluminum		Alloy 400		Titanium	
		Straight	Shape	Straight	Shape	Straight	Shape	Straight	Shape	Straight	Shape
		psig (bar)	psig (bar)	psig (bar)	psig (bar)	psig (bar)	psig (bar)	psig (bar)	psig (bar)	psig (bar)	psig (bar)
7/16-20	4AN	10 000 (689)	10 000 (689)	4 500 (310)	4 500 (310)	5 000 (345)	5 000 (345)	9 000 (620)	9 000 (620)	8 000 (551)	8 000 (551)
9/16-18	6AN	8 200 (564)	7 600 (523)	4 000 (275)	4 000 (275)	4 100 (282)	3 800 (262)	7 380 (508)	6 840 (471)	6 560 (452)	6 080 (410)
3/4-16	8AN										
1 1/16-12	12AN	7 000 (482)	6 300 (434)	3 000 (210)	3 000 (210)	3 500 (241)	3 150 (217)	6 300 (434)	5 670 (391)	5 600 (386)	5 040 (347)
1 5/16-12	16AN	5 000 (344)	4 100 (282)	2 500 (170)	2 500 (170)	2 500 (172)	2 050 (141)	4 500 (310)	3 690 (254)	4 000 (276)	3 280 (226)
1 5/8-12	20AN	2 000 (140)	2 000 (140)	2 000 (140)	2 000 (140)	1 000 (69)	1 000 (69)	1 800 (124)	1 800 (124)	1 600 (110)	1 600 (110)
1 7/8-12	24AN	1 500 (105)	1 500 (105)	1 500 (105)	1 500 (105)	700 (48)	750 (52)	1 350 (93)	1 350 (93)	1 200 (83)	1 200 (83)
2 1/2-12	32AN	1 125 (80)	1 125 (80)	1 125 (80)	1 125 (80)	500 (34)	560 (39)	1 010 (70)	1 010 (70)	900 (62)	900 (62)

O-Seal Pressure Ratings

Stainless steel and carbon steel O-seal fittings up to 1 in. and 25 mm are rated to 3000 psig (206 bar).

Positionable, ISO/BSP Parallel Thread (PR) Pressure Ratings

Pressure ratings are at ambient temperature.

ISO/BSP Male Pipe Size in.	316 SS, Carbon Steel, and Alloy (C-276, 2507, 625, 6-Moly, 825, and 600)	Brass and Aluminum	Alloy 400	Titanium
	psig (bar)	psig (bar)	psig (bar)	psig (bar)
1/8, 3/16, 1/4, 3/8	4568 (315)	2277 (157)	4104 (283)	3654 (252)
1/2, 3/4, 1	2320 (160)	1160 (80)	2088 (144)	1856 (128)

Pressure Ratings

ISO 228/BSP Parallel Thread (RS and RP) Pressure Ratings

Hydraulic pressure ratings are based on ISO 1179 at ambient temperature.

- RS and RP male connectors were tested with RP female connectors.
- RS end connections were tested with bonded RS gaskets.
- RP connections were tested without a gasket.
- Gasket selection is the responsibility of the system designer and user and may affect product performance.

ISO 228/BSP Parallel Thread RS Pressure Ratings

ISO/BSP Male Pipe Size in.	316 SS, Carbon Steel, and Alloy (C-276, 2507, 625, 6-Moly, 825, and 600)	Brass and Aluminum	Alloy 400	Titanium
	psig (bar)	psig (bar)	psig (bar)	psig (bar)
1/8, 1/4, 3/8	5800 (400)	2900 (200)	5220 (360)	4640 (320)
1/2	4700 (324)	2350 (162)	4220 (291)	3750 (259)
3/4	3620 (250)	1810 (125)	3260 (225)	2900 (200)
1				
1 1/4	2320 (160)	1160 (80)	2080 (144)	1850 (128)
1 1/2				

ISO 228/BSP Parallel Thread RP Pressure Ratings

ISO/BSP Male Pipe Size in.	316 SS, Carbon Steel, and Alloy (C-276, 2507, 625, 6-Moly, 825, and 600)	Brass and Aluminum	Alloy 400	Titanium
	psig (bar)	psig (bar)	psig (bar)	psig (bar)
1/8, 1/4, 3/8	5800 (400)	2900 (200)	5200 (360)	4640 (320)
1/2	4700 (324)	2350 (162)	4220 (291)	3750 (259)
3/4	2320 (160)	1160 (80)	2080 (144)	1850 (128)
1	1450 (100)	720 (50)	1300 (90)	1160 (80)
1 1/4				
1 1/2				

ISO 228/BSP/JIS Parallel Thread RG and RJ Pressure Ratings

ISO/BSP Male Pipe Size in.	316 SS, Carbon Steel, and Alloy (C-276, 2507, 625, 6-Moly, 825, and 600)	Brass and Aluminum	Alloy 400	Titanium
	psig (bar)	psig (bar)	psig (bar)	psig (bar)
1/8	5700 (392)	2850 (196)	5110 (352)	4560 (314)
1/4				
3/8				
1/2	3900 (288)	1950 (134)	3490 (240)	3120 (215)

Ordering Numbers and Dimensions

- See **How to Order**, below. Minimum order quantities may apply to certain materials and configurations.
- Dimensions are for reference only and are subject to change. Unless noted otherwise, dimensions shown are for stainless steel components and with Swagelok nuts finger-tight. For Swagelok nut dimensions, see page 57.
- CAD templates are available on www.swagelok.com.

Straight Fittings

Unions

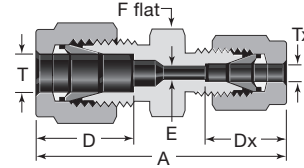
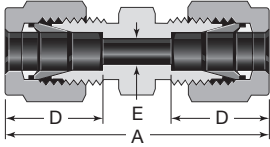

Union

Tube OD	Basic Ordering Number	Dimensions		
		A	D	E
Dimensions, in.				
1/16	-100-6	0.99	0.34	0.05
1/8	-200-6	1.40	0.50	0.09
3/16	-300-6	1.47	0.54	0.12
1/4	-400-6	1.61	0.60	0.19
5/16	-500-6	1.69	0.64	0.25
3/8	-600-6	1.77	0.66	0.28
1/2	-810-6	2.02	0.90	0.41
1/2	-810-6-0030 ^①	4.30	—	0.50
5/8	-1010-6	2.05	0.96	
3/4	-1210-6	2.11	1.02	0.62
7/8	-1410-6	2.17	1.02	0.72
1	-1610-6	2.55	1.23	0.88
1 1/8	B-1810-6			0.97
1 1/4	-2000-6	3.63	1.62	1.09
1 1/2	-2400-6	4.25	1.97	1.34
2	-3200-6	5.88	2.66	1.81
Dimensions, mm				
2	-2M0-6	35.6	12.9	1.7
3	-3M0-6	35.3		2.4
4	-4M0-6	37.3	13.7	2.4
6	-6M0-6	41.0	15.3	4.8
8	-8M0-6	43.2	16.2	6.4
10	-10M0-6	46.2	17.2	7.9
12	-12M0-6	51.2	22.8	9.5
14	-14M0-6	52.0	24.4	11.1
15	-15M0-6			11.9
16	-16M0-6			12.7
18	-18M0-6			15.1
20	-20M0-6	55.0	26.0	15.9
22	-22M0-6			18.3
25	-25M0-6	65.0	31.3	21.8
28	-28M0-6	85.0	36.6	
	B-28M0-6	65.4	31.6	24.6
30	-30M0-6	92.7	39.6	26.2
32	-32M0-6	97.3	42.0	28.6
38	-38M0-6	114	49.4	33.7
50	-50M0-6	146	65.0	45.2

^① Bored through.

Union (Metric to Fractional)

Tube OD		Basic Ordering Number	Dimensions					
T	Tx, in.		A	D	Dx	E	F	
Dimensions, mm								
2	1/8	-2M0-6-2	35.2	12.9	12.8	1.7	12	
	1/4	-2M0-6-4	38.6				14	
3	1/8	-3M0-6-2	35.2	12.9	12.8	2.4	12	
4	1/8	-4M0-6-2	36.5	13.7	12.8	2.4	12	
	1/4	-4M0-6-4	39.4				14	
6	1/16	-6M0-6-1	34.3	15.3	15.3	4.8	14	
	1/8	-6M0-6-2	38.5				14	
	1/4	-6M0-6-4	41.0				14	
	5/16	-6M0-6-5	42.3				14	
8	3/8	-6M0-6-6	43.2	16.2	16.8	4.8	16	
	1/4	-8M0-6-4	42.3				15	
10	1/8	-8M0-6-6	44.3	17.2	15.3	4.8	18	
	1/4	-10M0-6-2	41.8					14
	1/4	-10M0-6-4	44.5					14
	5/16	-10M0-6-5	45.1					14
12	3/8	-10M0-6-6	45.9	22.8	16.2	6.4	22	
	1/2	-12M0-6-4	47.0					16
	1/2	-12M0-6-5	47.8					16
	3/8	-12M0-6-6	48.4					16
14	1/2	-12M0-6-8	51.2	22.9	16.9	7.1	22	
	1/2	-12M0-6-8	51.2					9.5
14	1/2	-14M0-6-8	52.0	24.4	22.9	10.3	24	
15	1/2	-15M0-6-8	52.0	24.4	22.9	10.3	24	
16	5/8	-16M0-6-10	52.0	24.4	24.4	12.7	24	
18	3/4	-18M0-6-12	53.5	24.4	24.4	15.1	27	
20	1/2	-20M0-6-8	55.0	26.0	22.9	10.3	30	
	1	-20M0-6-16	62.8				31.3	15.9
25	1	-25M0-6-16	65.0	31.3	31.3	21.8	35	

How to Order

Select a basic ordering number. Example **-100-6**

Add a material designator. Example: **SS-100-6**

Material	Designator	Material	Designator
316 SS	SS	Alloy 2507	2507
Aluminum	A	Alloy C-276	HC
6-Moly	6MO	Brass	B
Alloy 400	M	Carbon steel	S
Alloy 600	INC	PTFE	T
Alloy 625	625	Titanium (grade 4)	TI
Alloy 825	825		

Refer to Installation Instructions, beginning on page 69.

Straight Fittings

Unions

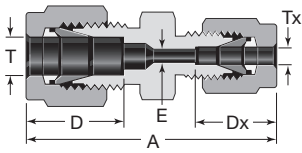

Reducing Union

Tube OD		Basic Ordering Number	Dimensions			
T	Tx		A	D	Dx	E
Dimensions, in.						
1/8	1/16	-200-6-1	1.22	0.50	0.34	0.05
3/16	1/16	-300-6-1	1.27	0.54	0.34	0.05
	1/8	-300-6-2	1.44		0.50	0.09
1/4	1/16	-400-6-1	1.35	0.60	0.34	0.05
	1/8	-400-6-2	1.52		0.50	0.09
	3/16	-400-6-3	1.55		0.54	0.12
5/16	1/8	-500-6-2	1.56	0.64	0.50	0.09
	1/4	-500-6-4	1.66		0.60	0.19
3/8	1/16	-600-6-1	1.44	0.66	0.34	0.05
	1/8	-600-6-2	1.61		0.50	0.09
	1/4	-600-6-4	1.70		0.60	0.19
	5/16	-600-6-5	1.74		0.64	0.25
1/2	1/8	-810-6-2	1.78	0.90	0.50	0.09
	1/4	-810-6-4	1.85		0.60	0.19
	3/8	-810-6-6	1.91		0.66	0.28
5/8	3/8	-1010-6-6	1.94	0.96	0.66	0.28
	1/2	-1010-6-8	2.05		0.90	0.41
3/4	1/4	-1210-6-4	1.94	0.96	0.60	0.19
	3/8	-1210-6-6	2.00		0.66	0.28
	1/2	-1210-6-8	2.11		0.90	0.41
	5/8	-1210-6-10	2.11		0.96	0.50
1	1/2	-1610-6-8	2.38	1.23	0.90	0.41
	3/4	-1610-6-12			0.96	0.62
Dimensions, mm						
3	2	-3M0-6-2M	35.3	12.9	12.9	1.7
6	2	-6M0-6-2M	38.6	15.3	12.9	1.7
	3	-6M0-6-3M	38.6		12.9	2.4
	4	-6M0-6-4M	39.4		13.7	2.4
8	6	-8M0-6-6M	42.3	16.2	15.3	4.8
10	6	-10M0-6-6M	44.5	17.2	15.3	4.8
	8	-10M0-6-8M	45.1		16.2	6.4
12	6	-12M0-6-6M	47.0	22.8	15.3	4.8
	8	-12M0-6-8M	47.8		16.2	6.4
	10	-12M0-6-10M	48.7		17.2	7.9
14	12	-14M0-6-12M	48.8	24.4	22.8	6.4
15	12	-15M0-6-12M	48.8	24.4	22.8	6.4
16	10	-16M0-6-10M	49.5	24.4	17.2	7.9
	12	-16M0-6-12M	52.0		22.8	9.5
18	12	-18M0-6-12M	53.5	24.4	22.8	9.5
25	18	-25M0-6-18M	61.0	31.3	24.4	15.1
	20	-25M0-6-20M	62.3		26.0	15.9
30	18	-30M0-6-18M	75.4	39.6	24.4	15.1
	20	-30M0-6-20M	75.4		26.0	15.9
	25	-30M0-6-25M	80.1		31.3	21.8
32	18	-32M0-6-18M	77.8	42.0	24.4	15.1
	20	-32M0-6-20M	77.8		26.0	15.9
	25	-32M0-6-25M	82.3		31.3	21.8
38	20	-38M0-6-20M	87.5	49.4	26.0	15.9
	25	-38M0-6-25M	92.0		31.3	21.8
	30	-38M0-6-30M	105		39.6	26.2

Refer to Installation Instructions, beginning on page 69.

Straight Fittings

Unions

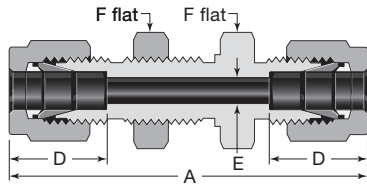

Bulkhead Union

Tube OD	Basic Ordering Number	Dimensions						Panel Hole Size	Max Panel Thickness
		A	D	E	F	F	F		
Dimensions, in.									
1/16	-100-61	1.24	0.34	0.05	5/16	13/64	0.12 ^①		
1/8	-200-61	2.02	0.50	0.09	1/2	21/64	0.50		
3/16	-300-61	2.11	0.54	0.12	9/16	25/64			
1/4	-400-61	2.27	0.60	0.19	5/8	29/64	0.40		
5/16	-500-61	2.39	0.64	0.25	11/16	33/64	0.44		
3/8	-600-61	2.45	0.66	0.28	3/4	37/64			
1/2	-810-61	2.80	0.90	0.41	15/16	49/64	0.50		
5/8	-1010-61	2.86	0.96	0.50	1 1/16	57/64			
3/4	-1210-61	3.11	0.96	0.62	1 3/16	1 1/64	0.66		
1	-1610-61	3.77	1.23	0.88	1 5/8	1 21/64	0.75		
1 1/4	-2000-61	4.85	1.62	1.09	1 7/8	1 41/64			
1 1/2	-2400-61	5.48	1.97	1.34	2 1/4	1 61/64			
2	-3200-61	7.10	2.66	1.81	2 3/4	2 41/64			
Dimensions, mm									
3	-3M0-61	51.3	12.9	2.4	14	8.3	12.7		
4	-4M0-61	53.6	13.7	2.4		9.9			
6	-6M0-61	57.7	15.3	4.8	16	11.5	10.2		
8	-8M0-61	61.0	16.2	6.4	18	13.1	11.2		
10	-10M0-61	63.7	17.2	7.9	22	16.3			
12	-12M0-61	71.0	22.8	9.5	24	19.5	12.7		
14	-14M0-61	72.5	24.4	11.1	27	22.5			
15	-15M0-61	72.5	24.4	11.9		22.8			
16	-16M0-61	72.5	24.4	12.7					
18	-18M0-61	78.9	24.4	15.1	30	26.0	16.8		
20	-20M0-61	84.5	26.0	15.9	35	29.0	19.0		
25	-25M0-61	96.0	31.3	21.8	41	34.0			
30	-30M0-61	124	39.6	26.2	50	40.5			
32	-32M0-61	128	42.0	28.6		42.5			
38	-38M0-61	145	49.4	33.7	60	50.5			

① Minimum panel thickness is 0.06 in.

Bulkhead Reducing Union

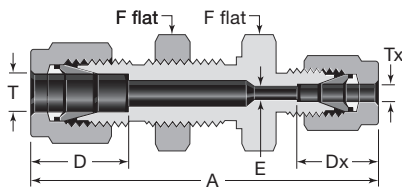

Tube OD		Basic Ordering Number	Dimensions						Panel Hole Size	Max Panel Thickness
T	Tx		A	D	Dx	E	F			
Dimensions, in.										
1/8	1/16	-200-61-1	1.85	0.50	0.34	0.05	1/2	21/64	0.50	
1/4	1/8	-400-61-2	2.17	0.60	0.50	0.09	5/8	29/64	0.40	
3/8	1/4	-600-61-4	2.39	0.66	0.60	0.19	3/4	37/64	0.44	
1/2	1/4	-810-61-4	2.63	0.90			15/16	49/64	0.50	

Bulkhead Reducing Union (Metric to Fractional)

Tube OD		Basic Ordering Number	Dimensions						Panel Hole Size	Max Panel Thickness
T	Tx, in.		A	D	Dx	E	F			
Dimensions, mm										
6	1/8	-6M0-61-2	55.1	15.3	12.7	2.4	16	11.5	10.2	

Refer to Installation Instructions, beginning on page 69.

Straight Fittings

Male Connectors

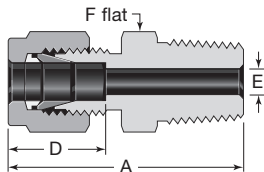

NPT

Tube OD	NPT Size	Basic Ordering Number	Dimensions			
			A	D	E ^①	F
Dimensions, in.						
1/16	1/16	-100-1-1	0.94	0.34	0.05	5/16
	1/8	-100-1-2	1.03			7/16
	1/4	-100-1-4	1.22			9/16
1/8	1/16	-200-1-1	1.17	0.50	0.09	7/16
	1/8	-200-1-2	1.20			7/16
	1/4	-200-1-4	1.40			9/16
	3/8	-200-1-6	1.41			11/16
	1/2	-200-1-8	1.66			7/8
3/16	1/8	-300-1-2	1.23	0.54	0.12	7/16
	1/4	-300-1-4	1.43			9/16
1/4	1/16	-400-1-1	1.29	0.60	0.12	1/2
	1/8	-400-1-2	1.29			1/2
	1/4	-400-1-4	1.49			9/16
	3/8	-400-1-6	1.51			11/16
	1/2	-400-1-8	1.76			7/8
	3/4	-400-1-12	1.82			1 1/16
5/16	1/8	-500-1-2	1.34	0.64	0.19	9/16
	1/4	-500-1-4	1.52			9/16
	3/8	-500-1-6	1.54			11/16
3/8	1/8	-600-1-2	1.39	0.66	0.19	5/8
	1/4	-600-1-4	1.57			5/8
	3/8	-600-1-6	1.57			11/16
	1/2	-600-1-8	1.82			7/8
	3/4	-600-1-12	1.88			1 1/16
	1	-600-1-16	2.14			1 3/8
1/2	1/8	-810-1-2	1.53	0.90	0.19	13/16
	1/4	-810-1-4	1.71			13/16
	3/8	-810-1-6	1.71			13/16
	1/2	-810-1-8	1.93			7/8
	3/4	-810-1-12	1.99			1 1/16
	1	-810-1-16	2.25			1 3/8
5/8	1/4	-1010-1-4	1.74	0.96	0.28	15/16
	3/8	-1010-1-6	1.74			15/16
	1/2	-1010-1-8	1.93			15/16
	3/4	-1010-1-12	1.99			1 1/16
3/4	3/8	-1210-1-6	1.80	0.96	0.41	1 1/16
	1/2	-1210-1-8	1.99			1 1/16
	3/4	-1210-1-12	1.99			1 1/16
	1	-1210-1-16	2.25			1 3/8
7/8	1/2	-1410-1-8	1.99	1.02	0.47	1 3/16
	3/4	-1410-1-12	1.99			1 3/16
	1	-1410-1-16	2.25			1 3/8
1	1/2	-1610-1-8	2.26	1.23	0.47	1 3/8
	3/4	-1610-1-12	2.26			1 3/8
	1	-1610-1-16	2.45			1 3/8
1 1/8	1	B-1810-1-16	2.45	1.23	0.88	1 5/8
1 1/4	1	-2000-1-16	3.04	1.62	0.88	1 3/4
	1 1/4	-2000-1-20	3.04			1 3/4
1 1/2	1 1/2	-2400-1-24	3.50	1.97	1.34	2 1/8
2	2	-3200-1-32	4.47	2.66	1.81	2 3/4

① The E dimension is the minimum nominal opening. These fittings may have a larger opening at the pipe/straight thread end.

Refer to Installation Instructions, beginning on page 69.

Tube OD	NPT Size in.	Basic Ordering Number	Dimensions					
			A	D	E ^①	F		
Dimensions, mm								
2	1/8	-2M0-1-2	30.5	12.9	1.7	12		
3	1/8	-3M0-1-2	30.5	12.9	2.4	12		
	1/4	-3M0-1-4	35.6			14		
4	1/8	-4M0-1-2	31.2	13.7	2.4	12		
	1/4	-4M0-1-4	36.3			14		
6	1/8	-6M0-1-2	32.8	15.3	4.8	14		
	1/4	-6M0-1-4	37.9			14		
	3/8	-6M0-1-6	38.4			18		
	1/2	-6M0-1-8	44.7			22		
8	1/8	-8M0-1-2	34.2	16.2	4.8	15		
	1/4	-8M0-1-4	38.7			15		
	3/8	-8M0-1-6	39.3			18		
	1/2	-8M0-1-8	45.6			22		
10	1/8	-10M0-1-2	36.3	17.2	4.8	18		
	1/4	-10M0-1-4	40.9			18		
	3/8	-10M0-1-6	40.9			18		
	1/2	-10M0-1-8	46.5			22		
12	3/4	-10M0-1-12	48.0	17.2	7.9	27		
	1/8	-12M0-1-2	38.8			22.8	4.8	22
	1/4	-12M0-1-4	43.4					22
	3/8	-12M0-1-6	43.4					22
	1/2	-12M0-1-8	49.0					22
3/4	-12M0-1-12	50.5	27					
14	1/4	-14M0-1-4	44.1	24.4	7.1	24		
	3/8	-14M0-1-6	44.1			24		
	1/2	-14M0-1-8	49.0			24		
15	1/2	-15M0-1-8	49.0	24.4	11.9	24		
16	3/8	-16M0-1-6	44.1	24.4	9.5	24		
	1/2	-16M0-1-8	49.0			24		
	3/4	-16M0-1-12	50.5			27		
18	1/2	-18M0-1-8	50.5	24.4	11.9	27		
	3/4	-18M0-1-12	50.5			27		
20	1/2	-20M0-1-8	52.3	26.0	11.9	30		
	3/4	-20M0-1-12	52.3			30		
22	3/4	-22M0-1-12	52.3	26.0	15.9	30		
	1	-22M0-1-16	57.1			35		
25	1/2	-25M0-1-8	57.5	31.3	11.9	35		
	3/4	-25M0-1-12	57.5			35		
	1	-25M0-1-16	62.3			35		
28	1	-28M0-1-16	72.4	36.6	21.8	41		
	1 1/4	-28M0-1-20	73.1			46		
	1	B-28M0-1-16	75.0			31.6	24.6	41
1 1/4	B-28M0-1-20	77.3	46					
30	1 1/4	-30M0-1-20	77.2	39.6	26.2	46		
32	1 1/4	-32M0-1-20	79.6	42.0	28.6	46		
38	1 1/2	-38M0-1-24	91.6	49.4	33.7	55		

① The E dimension is the minimum nominal opening. These fittings may have a larger opening at the pipe/straight thread end.

Straight Fittings

Male Connectors

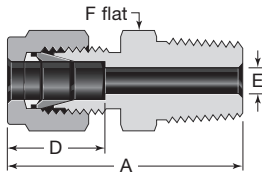

See page 9 for thread specifications.

ISO/BSP Tapered Thread (RT)

Tube OD	ISO Thread Size	Basic Ordering Number	Dimensions			
			A	D	E ^①	F
Dimensions, in.						
1/8	1/8	-200-1-2RT	1.20	0.50	0.09	7/16
	1/4	-200-1-4RT	1.40			9/16
1/4	1/8	-400-1-2RT	1.29	0.60	0.19	1/2
	1/4	-400-1-4RT	1.49			9/16
	3/8	-400-1-6RT	1.51			11/16
	1/2	-400-1-8RT	1.76			7/8
5/16	1/8	-500-1-2RT	1.34	0.64	0.19	9/16
	1/4	-500-1-4RT	1.52			
3/8	1/8	-600-1-2RT	1.39	0.66	0.19	5/8
	1/4	-600-1-4RT	1.57		0.28	5/8
	3/8	-600-1-6RT	1.57		0.28	11/16
	1/2	-600-1-8RT	1.82		0.28	7/8
	3/4	-600-1-12RT	1.88		0.28	1 1/16
1/2	1/4	-810-1-4RT	1.71	0.90	0.28	13/16
	3/8	-810-1-6RT	1.71		0.38	13/16
	1/2	-810-1-8RT	1.93		0.41	7/8
	3/4	-810-1-12RT	1.99		0.41	1 1/16
5/8	1/2	-1010-1-8RT	1.93	0.96	0.47	15/16
3/4	3/4	-1210-1-12RT	1.99	0.96	0.62	1 1/16
	1	-1210-1-16RT	2.25			1 3/8
1	3/4	-1610-1-12RT	2.26	1.23	0.63	1 3/8
	1	-1610-1-16RT	2.45		0.88	
1 1/4	1 1/4	-2000-1-20RT	3.04	1.62	1.09	1 3/4

① The E dimension is the minimum nominal opening. These fittings may have a larger opening at the pipe/straight thread end.

Tube OD	ISO Thread Size, in.	Basic Ordering Number	Dimensions			
			A	D	E ^①	F
Dimensions, mm						
2	1/8	-2M0-1-2RT	30.5	12.9	1.7	12
3	1/8	-3M0-1-2RT	30.5	12.9	2.4	12
	1/4	-3M0-1-4RT	35.6			14
4	1/8	-4M0-1-2RT	31.2	13.7	2.4	12
	1/4	-4M0-1-4RT	36.3			14
6	1/8	-6M0-1-2RT	32.8	15.3	4.8	14
	1/4	-6M0-1-4RT	37.9			14
	3/8	-6M0-1-6RT	38.4			18
	1/2	-6M0-1-8RT	44.7			22
8	1/8	-8M0-1-2RT	34.2	16.2	4.8	15
	1/4	-8M0-1-4RT	38.7		6.4	15
	3/8	-8M0-1-6RT	39.2		6.4	18
	1/2	-8M0-1-8RT	45.6		6.4	22
10	1/8	-10M0-1-2RT	36.3	17.2	4.8	18
	1/4	-10M0-1-4RT	40.9		7.1	18
	3/8	-10M0-1-6RT	40.9		7.9	18
	1/2	-10M0-1-8RT	46.5		7.9	22
	3/4	-10M0-1-12RT	48.0		7.9	27
12	1/4	-12M0-1-4RT	43.4	22.8	7.1	22
	3/8	-12M0-1-6RT	43.4		9.5	22
	1/2	-12M0-1-8RT	49.0		9.5	22
	3/4	-12M0-1-12RT	50.5		9.5	27
14	1/4	-14M0-1-4RT	44.1	24.4	7.1	24
	3/8	-14M0-1-6RT	44.1		9.5	
15	1/2	-15M0-1-8RT	49.0	24.4	11.9	24
16	1/4	-16M0-1-4RT	44.1	24.4	7.1	24
	3/8	-16M0-1-6RT	44.1		9.5	24
	1/2	-16M0-1-8RT	49.0		11.9	24
	3/4	-16M0-1-12RT	50.5		12.7	27
18	1/2	-18M0-1-8RT	50.5	24.4	11.9	27
	3/4	-18M0-1-12RT			15.1	
20	1/2	-20M0-1-8RT	52.3	26.0	11.9	30
	3/4	-20M0-1-12RT			15.9	
22	3/4	-22M0-1-12RT	52.3	26.0	15.9	30
	1	-22M0-1-16RT	57.1		18.3	35
25	1/2	-25M0-1-8RT	57.5	31.3	11.9	35
	3/4	-25M0-1-12RT	57.5		15.9	
	1	-25M0-1-16RT	62.3		21.8	
28	1	-28M0-1-16RT	72.4	36.6	21.8	41
	1 1/4	-28M0-1-20RT	73.1			46
	1	B-28M0-1-16RT	75.0			31.6
1 1/4	B-28M0-1-20RT	77.3	46			
30	1 1/4	-30M0-1-20RT	77.2	39.6	26.2	46
32	1 1/4	-32M0-1-20RT	79.6	42.0	28.6	46
38	1 1/2	-38M0-1-24RT	91.6	49.4	33.7	55

① The E dimension is the minimum nominal opening. These fittings may have a larger opening at the pipe/straight thread end.

Refer to Installation Instructions, beginning on page 69.

Straight Fittings

Male Connectors

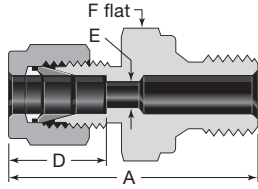

See page 9 for thread specifications.
ISO/BSP parallel gaskets are available. See page 60.

ISO/BSP Parallel Thread (RS)

Tube OD	ISO Thread Size	Basic Ordering Number	Dimensions			
			A	D	E ^①	F
Dimensions, in.						
1/8	1/8	-200-1-2RS	1.31	0.50	0.09	9/16
	1/4	-200-1-4RS	1.50			3/4
	3/8	-200-1-6RS	1.53			7/8
1/4	1/8	-400-1-2RS	1.40	0.60	0.16	9/16
	1/4	-400-1-4RS	1.59			3/4
	3/8	-400-1-6RS	1.62			7/8
	1/2	-400-1-8RS	1.70			1 1/16
3/8	1/8	-600-1-2RS	1.49	0.66	0.16	5/8
	1/4	-600-1-4RS	1.65			3/4
	3/8	-600-1-6RS	1.68			7/8
	1/2	-600-1-8RS	1.76			1 1/16
1/2	1/4	-810-1-4RS	1.76	0.90	0.23	13/16
	3/8	-810-1-6RS	1.79			7/8
	1/2	-810-1-8RS	1.87			1 1/16
3/4	1/2	-1210-1-8RS	1.92	0.96	0.47	1 1/16
	3/4	-1210-1-12RS	2.05			1 5/16
1	1/2	-1610-1-8RS	2.19	1.23	0.47	1 3/8
	3/4	-1610-1-12RS	2.27			1 3/8
	1	-1610-1-16RS	2.35			1 5/8

① The E dimension is the minimum nominal opening. These fittings may have a larger opening at the pipe/straight thread end.

Tube OD	ISO Thread Size, in.	Basic Ordering Number	Dimensions			
			A	D	E ^①	F
Dimensions, mm						
2	1/8	-2M0-1-2RS	33.3	12.9	1.7	14
3	1/8	-3M0-1-2RS	33.3	12.9	2.4	14
	1/4	-3M0-1-4RS	38.1			19
4	1/8	-4M0-1-2RS	34.0	13.7	2.4	14
6	1/8	-6M0-1-2RS	35.6	15.3	4.0	14
	1/4	-6M0-1-4RS	40.4			19
	3/8	-6M0-1-6RS	41.1			22
	1/2	-6M0-1-8RS	43.2			27
8	1/8	-8M0-1-2RS	36.6	16.2	4.0	15
	1/4	-8M0-1-4RS	41.4			19
	3/8	-8M0-1-6RS	42.2			22
	1/2	-8M0-1-8RS	44.2			27
10	1/4	-10M0-1-4RS	42.2	17.2	5.9	19
	3/8	-10M0-1-6RS	42.9			22
	1/2	-10M0-1-8RS	45.0			27
12	1/4	-12M0-1-4RS	44.5	22.8	5.9	22
	3/8	-12M0-1-6RS	45.5			22
	1/2	-12M0-1-8RS	47.5			27
	3/4	-12M0-1-12RS	52.1			35
14	3/8	-14M0-1-6RS	43.9	24.4	7.9	24
	1/2	-14M0-1-8RS	47.5			27
15	3/8	-15M0-1-6RS	45.5	24.4	7.9	24
	1/2	-15M0-1-8RS	47.5			27
	3/4	-15M0-1-12RS	52.8			35
16	3/8	-16M0-1-6RS	45.5	24.4	7.9	24
	1/2	-16M0-1-8RS	47.5			27
	3/4	-16M0-1-12RS	52.8			35
18	1/2	-18M0-1-8RS	48.8	24.4	11.9	27
	3/4	-18M0-1-12RS	52.1			35
20	1/2	-20M0-1-8RS	50.5	26.0	11.9	30
	3/4	-20M0-1-12RS	52.6			35
22	3/4	-22M0-1-12RS	52.6	26.0	15.9	35
	1	-22M0-1-16RS	54.9			41
25	3/4	-25M0-1-12RS	57.7	31.3	15.9	35
	1	-25M0-1-16RS	59.7			41
28	1	-28M0-1-16RS	69.9	36.6	19.8	41
	1 1/4	-28M0-1-20RS	72.9			50
	1	B-28M0-1-16RS	72.5			31.6
1 1/4	B-28M0-1-20RS	77.1	54			
30	1 1/4	-30M0-1-20RS	76.7	39.6	26.2	50
32	1 1/4	-32M0-1-20RS	79.2	42.0	28.6	50
38	1 1/2	-38M0-1-24RS	90.9	49.4	31.8	55

① The E dimension is the minimum nominal opening. These fittings may have a larger opening at the pipe/straight thread end.

Refer to Installation Instructions, beginning on page 69.

Straight Fittings

Male Connectors

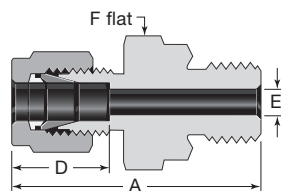

See page 9 for thread specifications.
ISO/BSP parallel gaskets are available. See page 60.

ISO/BSP Parallel Thread (RP)

Tube OD	ISO Thread Size	Basic Ordering Number	Dimensions			
			A	D	E ^①	F
Dimensions, in.						
1/8	1/8	-200-1-2RP	1.31	0.50	0.09	9/16
	1/4	-200-1-4RP	1.50			3/4
1/4	1/8	-400-1-2RP	1.40	0.60	0.16	9/16
	1/4	-400-1-4RP	1.59			3/4
1/2	3/8	-810-1-6RP	1.79	0.90	0.31	7/8
	1/2	-810-1-8RP	1.87			1 1/16
3/4	1/2	-1210-1-8RP	1.92	0.96	0.47	1 1/16
	3/4	-1210-1-12RP	2.05			1 5/16
1	1	-1610-1-16RP	2.35	1.23	0.78	1 5/8

① The E dimension is the minimum nominal opening. These fittings may have a larger opening at the pipe/straight thread end.

Bored-Through Fittings for Thermocouples, Dip Tubes, and Heat Exchanger Tees

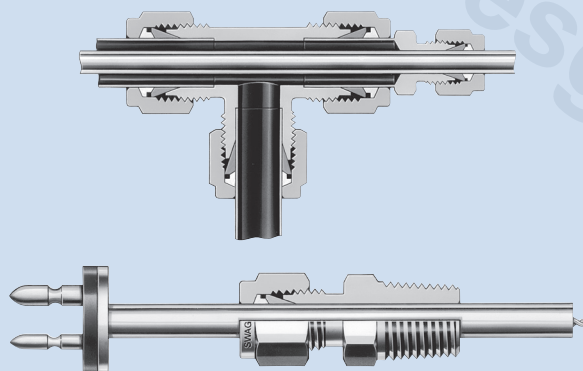

Swagelok bored-through male connectors accommodate thermocouples or dip tubes. Most male connectors are available as a bored-through fitting, but male connectors whose pipe thread end is small relative to the tube fitting end—such as **-600-1-2** or **-8M0-1-2RT**—cannot be bored through.

Swagelok bored-through reducers and standard Swagelok tees can be used to create a heat exchanger tee.

To order bored-through fittings, add **BT** to the ordering number. Example: SS-400-1-4BT

Bored-through fittings have a reduced pressure rating.

In general, we have multiplied the allowable working pressure of the tubing, as found on the *Tubing Data Sheet*, [MS-01-107](#), by the factors in the table to the right.

Tube OD	ISO Thread Size, in.	Basic Ordering Number	Dimensions			
			A	D	E ^①	F
Dimensions, mm						
3	1/8	-3M0-1-2RP	33.3	12.9	2.4	14
	1/4	-3M0-1-4RP	38.1			19
4	1/8	-4M0-1-2RP	34.0	13.7	2.4	14
6	1/8	-6M0-1-2RP	35.6	15.3	4.0	14
	1/4	-6M0-1-4RP	40.4			19
	3/8	-6M0-1-6RP	41.2			22
	1/2	-6M0-1-8RP	43.2			27
8	1/8	-8M0-1-2RP	36.5	16.2	4.0	15
	1/4	-8M0-1-4RP	41.3			19
	3/8	-8M0-1-6RP	41.9			22
	1/2	-8M0-1-8RP	44.1			27
10	1/4	-10M0-1-4RP	42.2	17.2	5.9	19
	3/8	-10M0-1-6RP	42.9			22
	1/2	-10M0-1-8RP	45.0			27
12	1/4	-12M0-1-4RP	45.4	22.8	5.9	22
	3/8	-12M0-1-6RP	45.4			22
	1/2	-12M0-1-8RP	47.5			27
	3/4	-12M0-1-12RP	52.1			35
15	1/2	-15M0-1-8RP	47.5	24.4	11.9	27
16	3/8	-16M0-1-6RP	45.4	24.4	7.9	24
	1/2	-16M0-1-8RP	47.5			27
18	1/2	-18M0-1-8RP	49.0	24.4	11.9	27
	3/4	-18M0-1-12RP	52.3			35
20	1/2	-20M0-1-8RP	50.5	26.0	11.9	30
	3/4	-20M0-1-12RP	52.5			35
22	3/4	-22M0-1-12RP	52.8	26.0	15.9	35
	1	-22M0-1-16RP	54.5			41
25	3/4	-25M0-1-12RP	57.8	31.3	15.9	35
	1	-25M0-1-16RP	59.8			41
28	1	-28M0-1-16RP	69.8	36.6	19.8	41
	1 1/4	-28M0-1-20RP	72.9			50
	1	B-28M0-1-16RP	72.5			41
	1 1/4	B-28M0-1-20RP	77.1	31.6	24.6	54
30	1 1/4	-30M0-1-20RP	76.8	39.6	26.2	50
32	1 1/4	-32M0-1-20RP	79.2	42.0	28.6	50
38	1 1/2	-38M0-1-24RP	92.1	49.4	31.8	55

① The E dimension is the minimum nominal opening. These fittings may have a larger opening at the pipe/straight thread end.

Reduced Pressure Rating Factors

Size (in.)	Size (mm)	Factor
Up to 1/2 in.	Up to 12 mm	0.75
Above 1/2 in. to 3/4 in.	Above 12 mm to 18 mm	0.50
Above 3/4 in.	Above 18 mm	0.25

Refer to Installation Instructions, beginning on page 69.

Straight Fittings

Male Connectors

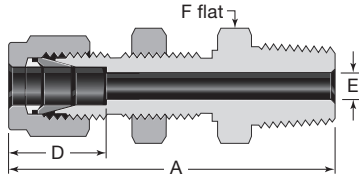

Bulkhead NPT

Tube OD	NPT Size in.	Basic Ordering Number	Dimensions					
			A	D	E ^①	F	Panel Hole Size	Max Panel Thickness
Dimensions, in.								
1/8	1/8	-200-11-2	1.83	0.50	0.09	1/2	21/64	0.50
1/4	1/8	-400-11-2	1.95	0.60	0.19	5/8	29/64	0.40
	1/4	-400-11-4	2.13					
3/8	1/4	-600-11-4	2.26	0.66	0.28	3/4	37/64	0.44
	3/8	-600-11-6	2.26					
	1/2	-600-11-8	2.51					
1/2	3/8	-810-11-6	2.49	0.90	0.38	15/16	49/64	0.50
	1/2	-810-11-8	2.71					
3/4	3/4	-1210-11-12	3.00	0.96	0.62	1 3/16	1 1/64	0.66
1	1	-1610-11-16	3.67	1.23	0.88	1 5/8	1 21/64	0.75
Dimensions, mm								
6	1/8	-6M0-11-2	49.5	15.3	4.8	16	11.5	10.2
	1/4	-6M0-11-4	53.6					
12	1/2	-12M0-11-8	68.8	22.8	9.5	24	19.5	12.7

① The E dimension is the minimum nominal opening. These fittings may have a larger opening at the pipe/straight thread end.

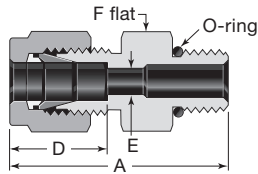

Adapts to SAE J1926/1 and ISO 11926-1 straight thread boss.

SAE/MS Straight Thread (ST)

Tube OD	SAE/MS Thread Size	Basic Ordering Number	Dimensions			
			A	D	E ^①	F
Dimensions, in.						
1/8	5/16-24	-200-1-2ST	1.18	0.50	0.09	7/16
	7/16-20	-200-1-4ST	1.24			9/16
	9/16-18	-200-1-6ST	1.31			11/16
1/4	5/16-24	-400-1-2ST	1.27	0.60	0.09	1/2
	7/16-20	-400-1-4ST	1.34			9/16
	9/16-18	-400-1-6ST	1.40			11/16
	3/4-16	-400-1-8ST	1.48			7/8
	7/8-14	-400-1-10ST	1.60			1
	5/16	1/2-20	-500-1-5ST			1.37
3/8	7/16-20	-600-1-4ST	1.40	0.66	0.18	5/8
	9/16-18	-600-1-6ST	1.46			11/16
	3/4-16	-600-1-8ST	1.54			7/8
	7/8-14	-600-1-10ST	1.66			1
	9/16-18	-810-1-6ST	1.54			0.90
3/4-16	-810-1-8ST	1.65	7/8			
7/8-14	-810-1-10ST	1.77	1			
1 1/16-12	-810-1-12ST	1.93	1 1/4			
5/8	3/4-16	-1010-1-8ST	1.65	0.96	0.42	15/16
	7/8-14	-1010-1-10ST	1.78			1
3/4	3/4-16	-1210-1-8ST	1.81	0.96	0.42	1 1/16
	1 1/16-12	-1210-1-12ST	1.93			1 1/4
	1 5/16-12	-1210-1-16ST	1.96			1 1/2
7/8	1 3/16-12	-1410-1-14ST	1.93	1.02	0.72	1 3/8
	1	1 1/16-12	-1610-1-12ST	2.10	1.23	0.66
1 5/16-12		-1610-1-16ST	2.14	1 1/2		
1 1/4	1 5/8-12	-2000-1-20ST	2.69	1.62	1.09	1 7/8
1 1/2	1 7/8-12	-2400-1-24ST	3.06	1.97	1.34	2 1/8
2	2 1/2-12	-3200-1-32ST	4.00	2.66	1.81	2 3/4

Refer to Installation Instructions, beginning on page 69.

Tube OD	SAE/MS Thread Size	Basic Ordering Number	Dimensions			
			A	D	E ^①	F
Dimensions, mm						
6	9/16-18	-6M0-1-6ST	35.6	15.3	4.8	18
10	9/16-18	-10M0-1-6ST	37.3	17.2	7.1	18
	3/4-16	-10M0-1-8ST	39.4			22
12	7/16-20	-12M0-1-4ST	40.6	22.8	5.2	22
	9/16-18	-12M0-1-6ST	39.9			7.1
	3/4-16	-12M0-1-8ST	41.9			9.5

① The E dimension is the minimum nominal opening. These fittings may have a larger opening at the pipe/straight thread end.

Long SAE/MS Straight Thread (ST)

Tube OD	SAE/MS Thread Size	Basic Ordering Number	Dimensions			
			A	D	E ^①	F
Dimensions, in.						
1/4	7/16-20	-400-1L-4ST	2.26	0.60	0.19	9/16
1/2	3/4-16	-810-1L-8ST	3.01	0.90	0.41	7/8

① The E dimension is the minimum nominal opening. These fittings may have a larger opening at the pipe/straight thread end.

For ST and ST positionable fittings used in ECE-R110 applications, add the **DE** O-ring suffix to the ordering number. Example: SS-600-1-6STDE

① The E dimension is the minimum nominal opening. These fittings may have a larger opening at the pipe/straight thread end.

Straight Fittings

Male Connectors

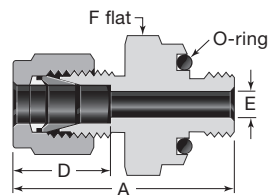
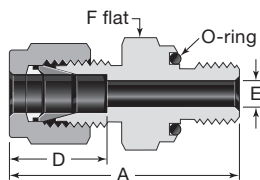

O-Seal (SAE/MS Straight Thread)

Tube OD	SAE/MS Thread Size	Basic Ordering Number	Dimensions			
			A	D	E ^①	F
Dimensions, in.						
1/16	5/16-24	-100-1-OR	1.05	0.34	0.05	9/16
1/8	5/16-24	-200-1-OR	1.29	0.50	0.09	9/16
3/16	3/8-24	-300-1-OR	1.35	0.54	0.12	5/8
1/4	7/16-20	-400-1-OR	1.51	0.60	0.19	3/4
5/16	1/2-20	-500-1-OR	1.60	0.64	0.25	7/8
3/8	9/16-18	-600-1-OR	1.67	0.66	0.28	15/16
1/2	3/4-16	-810-1-OR	1.81	0.90	0.41	1 1/8
3/4	1 1/16-12	-1210-1-OR	2.06	0.96	0.62	1 1/2
1	1 5/16-12	-1610-1-OR	2.29	1.23	0.88	1 3/4

① The E dimension is the minimum nominal opening. These fittings may have a larger opening at the pipe/straight thread end.

O-Seal (NPT)

Tube OD	NPT Size	Basic Ordering Number	Dimensions			
			A	D	E ^①	F
Dimensions, in.						
1/8	1/8	-200-1-2-OR	1.29	0.50	0.09	3/4
1/4	1/8	-400-1-2-OR	1.38	0.60	0.19	3/4
	1/4	-400-1-4-OR	1.51			15/16
3/8	1/4	-600-1-4-OR	1.57	0.66	0.28	15/16
	3/8	-600-1-6-OR	1.63			1 1/8
	1/2	-600-1-8-OR	1.85			1 5/16
1/2	1/2	-810-1-8-OR	1.96	0.90	0.41	1 5/16

① The E dimension is the minimum nominal opening. These fittings may have a larger opening at the pipe/straight thread end.

Mounting Dimensions for O-Seal Fittings

For a raised surface, see Fig. 1. The minimum diameter allows metal-to-metal contact outside of the O-ring sealing diameter to prevent O-ring extrusion.

For a recessed hole that allows the round shoulder of the O-seal fitting into the recess, see Fig. 2.

For a recessed hole that allows the hex of the O-seal fitting into the recess, see Fig. 3.

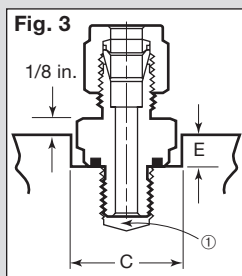
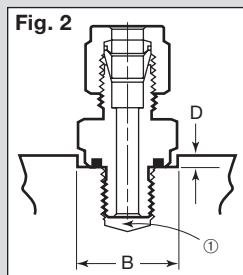
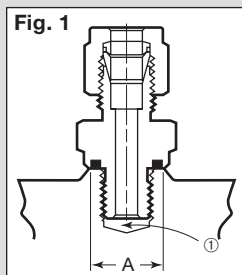

① Allow clearance for full thread.

SAE/MS Thread Size	NPT Size	A Min Dia	B Min Dia	C Min Dia	D Max Depth	E Max Depth
Dimensions, in.						
5/16-24	—	0.50	0.59	0.66	0.09	0.16
5/16-24						0.22
—	1/8	0.69	0.78	0.88	0.16	0.28
3/8-24	—	0.56	0.66	0.75	0.09	0.22
7/16-20	—	0.69	0.78	0.88	0.16	0.28
—	1/8					
—	1/4	0.87	0.97	1.09		0.31
1/2-20	—	0.75	0.91	1.03		
9/16-18	—	0.81	0.97	1.09		0.34
—	1/4	0.87				
—	3/8	1.00	1.16	1.31	0.22	0.44
—	1/2	1.22	1.34	1.53		
3/4-16	—	1.00	1.16	1.31	0.16	0.34
—	1/2	1.22	1.34	1.53	0.44	
1 1/16-12	—	1.41	1.53	1.75		0.22
1 5/16-12	—	1.69	1.78	2.03	0.56	

Refer to Installation Instructions, beginning on page 69.

Straight Fittings

Male Connectors

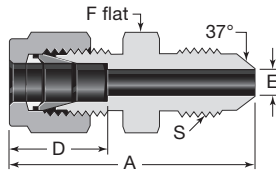

AN Fitting

Tube OD	AN Tube Flare Size	Basic Ordering Number	Dimensions				
			A	D	E ^①	F	S
Dimensions, in.							
1/16	1/8	-100-6-2AN	1.07	0.34	0.05	7/16	5/16-24UNJF-3
1/8	1/8	-200-6-2AN	1.27	0.50	0.06	7/16	5/16-24UNJF-3
	1/4	-200-6-4AN	1.38		0.09	1/2	7/16-20UNJF-3
1/4	1/4	-400-6-4AN	1.48	0.60	0.17	1/2	7/16-20UNJF-3
5/16	5/16	-500-6-5AN	1.51	0.64	0.23	9/16	1/2-20UNJF-3
3/8	1/4	-600-6-4AN	1.56	0.66	0.17	5/8	7/16-20UNJF-3
	3/8	-600-6-6AN			0.28		9/16-18UNJF-3
1/2	1/2	-810-6-8AN	1.81	0.90	0.39	13/16	3/4-16UNJF-3
3/4	3/4	-1210-6-12AN	2.10	0.96	0.61	1 1/8	1 1/16-12UNJ-3
1	1	-1610-6-16AN	2.42	1.23	0.84	1 3/8	1 5/16-12UNJ-3

① The E dimension is the minimum nominal opening. These fittings may have a larger opening at the pipe/straight thread end.

AN Bulkhead Fitting

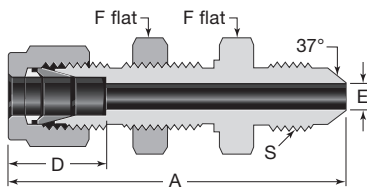

Tube OD	AN Tube Flare Size	Basic Ordering Number	Dimensions					Panel Hole Size	Max Panel Thickness
			A	D	E	F	S		
Dimensions, in.									
1/4	1/4	-400-61-4AN	2.12	0.60	0.17	5/8	7/16-20UNJF-3	29/64	0.40
3/8	3/8	-600-61-6AN	2.25	0.66	0.28	3/4	9/16-18UNJF-3	37/64	0.44
1/2	1/2	-810-61-8AN	2.59	0.90	0.39	15/16	3/4-16UNJF-3	49/64	0.50
3/4	3/4	-1210-61-12AN	3.11	0.96	0.61	1 3/16	1 1/16-12UNJ-3	1 1/64	0.66
1	1	-1610-61-16AN	3.64	1.23	0.84	1 5/8	1 5/16-12UNJ-3	1 21/64	0.75

Refer to Installation Instructions, beginning on page 69.

Straight Fittings

Male Connectors

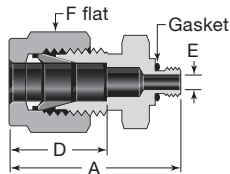

10-32 Thread

Tube OD	Basic Ordering Number	Dimensions			
		A	D	E ^①	F
Dimensions, in.					
1/8	-200-1-0157	0.95	0.50	0.09	7/16
1/4	-400-1-0256	1.08	0.60		9/16

① The E dimension is the minimum nominal opening. These fittings may have a larger opening at the pipe/straight thread end.

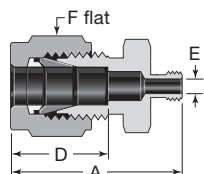

M5 × 0.8 Thread

Tube OD	Basic Ordering Number	Dimensions			
		A	D	E ^①	F
Dimensions, mm					
6	-6M0-1-0046	29.2	15.3	2.0	14

① The E dimension is the minimum nominal opening. These fittings may have a larger opening at the pipe/straight thread end.

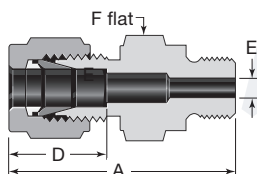

Metric Thread (RS)

Tube OD	Basic Ordering Number	Dimensions			
		A	D	E ^①	F
Dimensions, mm					
6	-6M0-1-M10X1.0RS	36.3	15.3	3.2	15
	-6M0-1-M12X1.0RS	40.4		4.8	18
12	-12M0-1-M16X1.5RS	45.5	22.8	9.5	22

① The E dimension is the minimum nominal opening. These fittings may have a larger opening at the pipe/straight thread end.

Weld Connectors

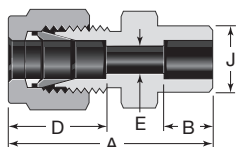

Tube Socket Weld

Tube OD	Socket Weld Size	Basic Ordering Number	Dimensions				
			A	B	D	E	J
Dimensions, in.							
1/8	1/8	-200-6-2W	1.14	0.10	0.50	0.09	0.29
1/4	1/4	-400-6-4W	1.32	0.28	0.60	0.19	0.48
3/8	3/8	-600-6-6W	1.48	0.31	0.66	0.28	0.60
1/2	1/2	-810-6-8W	1.62	0.38	0.90	0.41	0.73
3/4	3/4	-1210-6-12W	1.71	0.44	0.96	0.62	1.04
1	1	-1610-6-16W	2.07	0.62	1.23	0.88	1.36

Refer to Installation Instructions, beginning on page 69.

Straight Fittings

Weld Connectors

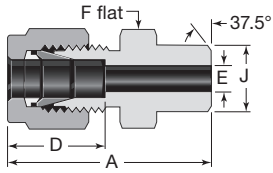

Male Pipe Weld (Fractional)

Tube OD	Pipe Weld Size	Basic Ordering Number	Dimensions				
			A	D	E ^①	F	J
Dimensions, in.							
1/8	1/8	-200-1-2W	1.20	0.50	0.09	7/16	0.405
3/16	1/8	-300-1-2W	1.23	0.54	0.12	7/16	0.405
1/4	1/8	-400-1-2W	1.29	0.60	0.19	1/2	0.405
	1/4	-400-1-4W	1.49			9/16	0.540
5/16	1/8	-500-1-2W	1.34	0.64	0.21	9/16	0.405
	1/4	-500-1-4W	1.52				0.540
3/8	1/4	-600-1-4W	1.57	0.66	0.28	5/8	0.540
	3/8	-600-1-6W	1.57			11/16	0.675
	1/2	-600-1-8W	1.82			7/8	0.840
	3/4	-600-1-12W	1.88			1 1/6	1.050
1/2	3/8	-810-1-6W	1.71	0.90	0.41	13/16	0.675
	1/2	-810-1-8W	1.93			7/8	0.840
	3/4	-810-1-12W	1.99			1 1/16	1.050
	1	-810-1-16W	2.25			1 3/8	1.315
5/8	1/2	-1010-1-8W	1.93	0.96	0.50	15/16	0.840
3/4	1/2	-1210-1-8W	1.99	0.96	0.55	1 1/16	0.840
	3/4	-1210-1-12W			0.62		
1	1	-1610-1-16W	2.45	1.23	0.88	1 3/8	1.315
1 1/4	1 1/4	-2000-1-20W	3.04	1.62	1.09	1 3/4	1.660
1 1/2	1 1/2	-2400-1-24W	3.50	1.97	1.34	2 1/8	1.900
2	2	-3200-1-32W	4.47	2.66	1.81	2 3/4	2.375

① The E dimension is the minimum nominal opening. These fittings may have a larger opening at the weld end. Wall thickness at the weld end is based on schedule 80 pipe.

Male Pipe Weld (Metric to Fractional)

Tube OD	Pipe Weld Size in.	Basic Ordering Number	Dimensions					
			A	D	E ^①	F	F, in. ^②	J
Dimensions, mm								
3	1/8	-3M0-1-2W	30.5	12.9	2.4	12	1/2	10.3
4	1/8	-4M0-1-2W	31.2	13.7	2.4	12	1/2	10.3
6	1/8	-6M0-1-2W	32.8	15.3	4.8	14	1/2	10.3
	1/4	-6M0-1-4W	37.9				9/16	13.7
8	1/8	-8M0-1-2W	34.2	16.2	5.4	15	9/16	10.3
	1/4	-8M0-1-4W	38.7		6.4	15	9/16	13.7
	1/2	-8M0-1-8W	45.6		6.4	22	7/8	21.3
10	1/4	-10M0-1-4W	40.9	17.2	7.5	18	11/16	13.7
	3/8	-10M0-1-6W	40.9		7.9	18	11/16	17.1
	1/2	-10M0-1-8W	46.5		7.9	22	7/8	21.3
12	1/4	-12M0-1-4W	43.4	22.8	7.5	22	13/16	13.7
	3/8	-12M0-1-6W	43.4		9.5	22	13/16	17.1
	1/2	-12M0-1-8W	49.0		9.5	22	7/8	21.3
	3/4	-12M0-1-12W	50.5		9.5	27	1 1/16	26.7
14	3/8	-14M0-1-6W	44.1	24.4	10.7	24	15/16	17.1
15	1/2	-15M0-1-8W	49.0	24.4	11.9	24	15/16	21.3
16	1/2	-16M0-1-8W	49.0	24.4	12.7	24	15/16	21.3
18	1/2	-18M0-1-8W	50.5	24.4	13.9	27	1 1/16	21.3
30	1 1/4	-30M0-1-20W	77.2	39.6	26.2	46	46 mm	42.2
32	1 1/4	-32M0-1-20W	79.6	42.0	28.6	46	46 mm	42.2
38	1 1/2	-38M0-1-24W	91.6	49.4	33.7	55	55 mm	48.3

① The E dimension is the minimum nominal opening. These fittings may have a larger opening at the weld end. Wall thickness at the weld end is based on schedule 80 pipe.

② This dimension is for steel and aluminum fittings.

Refer to Installation Instructions, beginning on page 69.

Straight Fittings

Female Connectors

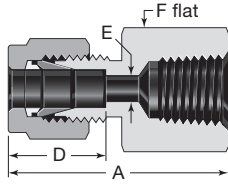

NPT

Tube OD	NPT Size	Basic Ordering Number	Dimensions			
			A	D	E	F
Dimensions, in.						
1/16	1/16	-100-7-1	0.93	0.34	0.05	7/16
	1/8	-100-7-2	0.96			9/16
1/8	1/8	-200-7-2	1.13	0.50	0.09	9/16
	1/4	-200-7-4	1.32			3/4
3/16	1/8	-300-7-2	1.17	0.54	0.12	9/16
1/4	1/8	-400-7-2	1.23	0.60	0.19	9/16
	1/4	-400-7-4	1.41			3/4
	3/8	-400-7-6	1.48			7/8
	1/2	-400-7-8	1.67			1 1/16
5/16	1/8	-500-7-2	1.26	0.64	0.25	9/16
	1/4	-500-7-4	1.45			3/4
3/8	1/8	-600-7-2	1.29	0.66	0.28	5/8
	1/4	-600-7-4	1.48			3/4
	3/8	-600-7-6	1.54			7/8
	1/2	-600-7-8	1.73			1 1/16
	3/4	-600-7-12	1.88			1 5/16
1/2	1/4	-810-7-4	1.59	0.90	0.41	13/16
	3/8	-810-7-6	1.65			7/8
	1/2	-810-7-8	1.84			1 1/16
	3/4	-810-7-12	1.90			1 5/16
5/8	3/8	-1010-7-6	1.65	0.96	0.50	15/16
	1/2	-1010-7-8	1.84			1 1/16
	3/4	-1010-7-12	1.90			1 5/16
3/4	1/2	-1210-7-8	1.84	0.96	0.62	1 1/16
	3/4	-1210-7-12	1.90			1 5/16
7/8	3/4	-1410-7-12	1.96	1.02	0.72	1 5/16
1	3/4	-1610-7-12	2.10	1.23	0.88	1 3/8
	1	-1610-7-16	2.45			1 5/8
1 1/4	1 1/4	-2000-7-20	2.94	1.62	1.09	2 1/8
1 1/2	1 1/2	-2400-7-24	3.28	1.97	1.34	2 3/8
2	2	-3200-7-32	4.00	2.66	1.81	2 7/8

Tube OD	NPT Size in.	Basic Ordering Number	Dimensions			
			A	D	E	F
Dimensions, mm						
3	1/8	-3M0-7-2	28.7	12.9	2.4	14
	1/4	-3M0-7-4	33.5			19
4	1/8	-4M0-7-2	29.7	13.7	2.4	14
6	1/8	-6M0-7-2	31.3	15.3	4.8	14
	1/4	-6M0-7-4	35.8			19
	3/8	-6M0-7-6	37.6			22
	1/2	-6M0-7-8	42.5			27
8	1/8	-8M0-7-2	32.1	16.2	6.4	15
	1/4	-8M0-7-4	37.0			19
	3/8	-8M0-7-6	38.5			22
	1/2	-8M0-7-8	43.3			27
10	1/4	-10M0-7-4	37.8	17.2	7.9	19
	3/8	-10M0-7-6	39.4			22
	1/2	-10M0-7-8	44.2			27
12	1/4	-12M0-7-4	40.3	22.8	9.5	22
	3/8	-12M0-7-6	41.9			22
	1/2	-12M0-7-8	46.7			27
15	1/2	-15M0-7-8	46.7	24.4	11.9	27
16	1/2	-16M0-7-8	46.9	24.4	12.7	27
20	1/2	-20M0-7-8	47.9	26.0	15.9	30
	3/4	-20M0-7-12	49.7			35
22	3/4	-22M0-7-12	49.7	26.0	18.3	35
	1	-22M0-7-16	57.9			41
25	3/4	-25M0-7-12	53.4	31.3	21.8	35
	1	-25M0-7-16	62.3			41

Refer to Installation Instructions, beginning on page 69.

Straight Fittings

Female Connectors

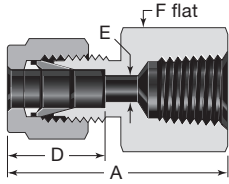

See page 9 for thread specifications.

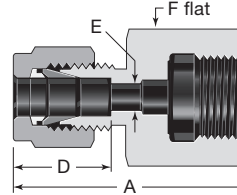

ISO/BSP parallel thread (RJ) fittings are available in stainless steel only. See page 9 for thread specifications.

ISO/BSP Tapered Thread (RT)

Tube OD	ISO Thread Size in.	Basic Ordering Number	Dimensions			
			A	D	E	F
Dimensions, in.						
1/8	1/8	-200-7-2RT	1.13	0.50	0.09	9/16
1/4	1/8	-400-7-2RT	1.23	0.60	0.19	9/16
	1/4	-400-7-4RT	1.41			3/4
	3/8	-400-7-6RT	1.48			7/8
	1/2	-400-7-8RT	1.67			1 1/16
3/8	1/4	-600-7-4RT	1.48	0.66	0.28	3/4
	3/8	-600-7-6RT	1.54			7/8
	1/2	-600-7-8RT	1.73			1 1/16
1/2	1/4	-810-7-4RT	1.59	0.90	0.41	13/16
	3/8	-810-7-6RT	1.65			7/8
	1/2	-810-7-8RT	1.84			1 1/16
Dimensions, mm						
3	1/8	-3M0-7-2RT	28.7	12.9	2.4	14
6	1/8	-6M0-7-2RT	31.3	15.3	4.8	14
	1/4	-6M0-7-4RT	35.8			19
	3/8	-6M0-7-6RT	37.6			22
	1/2	-6M0-7-8RT	42.5			27
8	1/8	-8M0-7-2RT	32.1	16.2	6.4	15
	1/4	-8M0-7-4RT	37.0			19
	3/8	-8M0-7-6RT	38.5			22
	1/2	-8M0-7-8RT	43.3			27
10	1/8	-10M0-7-2RT	33.0	17.2	7.9	18
	1/4	-10M0-7-4RT	37.8			19
	3/8	-10M0-7-6RT	39.4			22
	1/2	-10M0-7-8RT	44.2			27
12	1/8	-12M0-7-2RT	35.5	22.8	9.5	22
	1/4	-12M0-7-4RT	40.3			22
	3/8	-12M0-7-6RT	41.9			22
	1/2	-12M0-7-8RT	46.7			27
	3/4	-12M0-7-12RT	49.0			35
15	3/8	-15M0-7-6RT	41.9	24.4	11.9	24
	1/2	-15M0-7-8RT	46.7			27
20	1/2	-20M0-7-8RT	47.9	26.0	15.9	30
	3/4	-20M0-7-12RT	49.7			35
22	3/4	-22M0-7-12RT	49.7	26.0	18.3	35
	1	-22M0-7-16RT	57.9			41
25	3/4	-25M0-7-12RT	53.4	31.3	21.8	35
	1	-25M0-7-16RT	62.3			41

ISO/BSP Parallel Thread (RJ)

Tube OD	ISO Thread Size in.	Ordering Number	Dimensions			
			A	D	E	F
Dimensions, in.						
1/8	1/8	SS-200-7-2RJ	1.19	0.50	0.09	9/16
1/4	1/4	SS-400-7-4RJ	1.48	0.60	0.18	3/4
	3/8	SS-400-7-6RJ	1.48			15/16
	1/2	SS-400-7-8RJ	1.71			1 1/16
5/16	1/4	SS-500-7-4RJ	1.51	0.64	0.22	3/4
	1/2	SS-500-7-8RJ	1.61			1 1/16
3/8	1/4	SS-600-7-4RJ	1.54	0.66	0.22	3/4
	3/8	SS-600-7-6RJ	1.52			15/16
	1/2	SS-600-7-8RJ	1.65			1 1/16
1/2	1/4	SS-810-7-4RJ	1.65	0.90	0.22	13/16
	3/8	SS-810-7-6RJ	1.75			15/16
	1/2	SS-810-7-8RJ	1.90			1 1/16
Dimensions, mm						
6	1/4	SS-6M0-7-4RJ	37.6	15.3	4.8	19
	3/8	SS-6M0-7-6RJ	37.6			24
	1/2	SS-6M0-7-8RJ	43.5			27
8	1/4	SS-8M0-7-4RJ	38.5	16.2	5.5	19
	3/8	SS-8M0-7-6RJ	36.2			24
	1/2	SS-8M0-7-8RJ	41.0			27
10	1/4	SS-10M0-7-4RJ	39.4	17.2	5.5	19
	3/8	SS-10M0-7-6RJ	38.8			24
	1/2	SS-10M0-7-8RJ	42.1			27
12	1/4	SS-12M0-7-4RJ	41.9	22.8	5.5	22
	3/8	SS-12M0-7-6RJ	44.4			24
	1/2	SS-12M0-7-8RJ	48.2			27

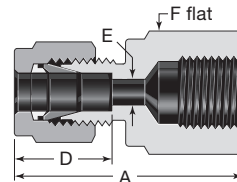

See page 9 for thread specifications.

ISO/BSP Parallel Thread (RP)

Tube OD	ISO Thread Size in.	Basic Ordering Number	Dimensions			
			A	D	E	F
Dimensions, mm						
6	1/8	-6M0-7-2RP	33.5	15.3	4.8	14
	1/4	-6M0-7-4RP	39.4			19
22	3/4	-22M0-7-12RP	53.3	26.0	18.3	35
25	1	-25M0-7-16RP	63.9	26.5	21.8	40

Refer to Installation Instructions, beginning on page 69.

Straight Fittings

Female Connectors

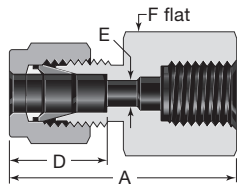

See page 9 for thread specifications.
ISO/BSP parallel gaskets are available.
See page 60.

ISO/BSP Parallel Thread (RG, Gauge)

Tube OD	ISO Thread Size in.	Basic Ordering Number	Dimensions			
			A	D	E	F
Dimensions, in.						
1/8	1/4	-200-7-4RG	1.39	0.59	0.09	3/4
1/4	1/8	-400-7-2RG	1.26	0.60	0.18	9/16
	1/4	-400-7-4RG	1.48		0.19	3/4
	3/8	-400-7-6RG	1.48		0.19	15/16
	1/2	-400-7-8RG	1.71		0.19	1 1/16
5/16	1/4	-500-7-4RG	1.51	0.64	0.22	3/4
	1/2	-500-7-8RG	1.61		0.28	1 1/16
3/8	1/4	-600-7-4RG	1.54	0.66	0.22	3/4
	3/8	-600-7-6RG	1.52		0.26	15/16
	1/2	-600-7-8RG	1.65		0.28	1 1/16
1/2	3/8	-810-7-6RG	1.75	0.90	0.26	15/16
	1/2	-810-7-8RG	1.90		0.28	1 1/16
Dimensions, mm						
3	1/4	-3M0-7-4RG	35.3	12.9	2.4	19
6	1/8	-6M0-7-2RG	32.0	15.3	4.5	14
	1/4	-6M0-7-4RG	37.6		4.8	19
	3/8	-6M0-7-6RG	37.6		4.8	24
	1/2	-6M0-7-8RG	43.5		4.8	27
8	1/4	-8M0-7-4RG	38.5	16.2	5.5	19
	3/8	-8M0-7-6RG	36.2		6.5	24
	1/2	-8M0-7-8RG	41.0		7.0	27
10	1/4	-10M0-7-4RG	39.4	17.2	5.5	19
	3/8	-10M0-7-6RG	38.8		6.5	24
	1/2	-10M0-7-8RG	42.1		7.0	27
12	1/4	-12M0-7-4RG	41.9	22.8	5.5	22
	3/8	-12M0-7-6RG	44.4		6.5	24
	1/2	-12M0-7-8RG	48.2		7.0	27
20	1/2	-20M0-7-8RG	54.3	26.0	7.0	30
22	1/2	-22M0-7-8RG	54.3	26.0	7.0	30

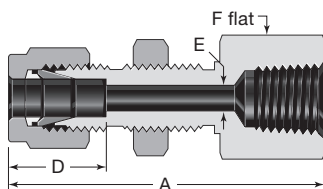

Bulkhead NPT

Tube OD	NPT Size in.	Basic Ordering Number	Dimensions					
			A	D	E	F	Panel Hole Size	Max Panel Thickness
Dimensions, in.								
1/8	1/8	-200-71-2	1.76	0.50	0.09	9/16	21/64	0.50
1/4	1/8	-400-71-2	1.85	0.60	0.19	5/8	29/64	0.40
	1/4	-400-71-4	2.04			3/4		
3/8	1/4	-600-71-4	2.17	0.66	0.28	3/4	37/64	0.44
1/2	3/8	-810-71-6	2.43	0.90	0.41	15/16	49/64	0.50
	1/2	-810-71-8	2.62			1 1/16		
Dimensions, mm								
6	1/4	-6M0-71-4	51.8	15.3	4.8	19	11.5	10.2
12	1/2	-12M0-71-8	66.5	22.8	9.5	27	19.5	12.7

Refer to Installation Instructions, beginning on page 69.

Straight Fittings

Reducers

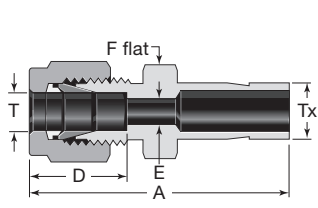

1 in. and Under

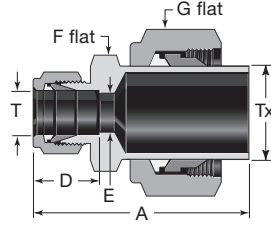

Over 1 in.

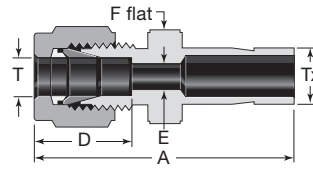

25 mm and Under

Reducer (Fractional)

Tube OD		Basic Ordering Number	Dimensions				
T	Tx		A	D	E	F	G
Dimensions, in.							
1/16	1/8 1/4	-100-R-2 -100-R-4	1.15 1.24	0.34	0.05	5/16	—
1/8	1/16	-200-R-1	1.14	0.50	0.03	7/16	—
	1/8	-200-R-2	1.32		0.08	7/16	
	3/16	-200-R-3	1.35		0.09	7/16	
	1/4	-200-R-4	1.42		0.09	7/16	
	3/8	-200-R-6	1.48		0.09	7/16	
3/16	1/8	-300-R-2	1.37	0.54	0.08	7/16	—
	1/4	-300-R-4	1.46		0.12	—	
1/4	1/8	-400-R-2	1.45	0.60	0.08	1/2	—
	3/16	-400-R-3	1.48		0.12	1/2	
	1/4	-400-R-4	1.54		0.17	1/2	
	5/16	-400-R-5	1.57		0.19	1/2	
	3/8	-400-R-6	1.60		0.19	1/2	
	1/2	-400-R-8	1.82		0.19	9/16	
	5/8	-400-R-10	1.89		0.19	11/16	
3/4	-400-R-12	1.88	0.19	13/16			
5/16	3/8	-500-R-6	1.65	0.64	0.25	9/16	—
	1/2	-500-R-8	1.87		—	—	
3/8	1/4	-600-R-4	1.63	0.66	0.17	5/8	—
	3/8	-600-R-6	1.70		0.27	5/8	
	1/2	-600-R-8	1.91		0.28	5/8	
	5/8	-600-R-10	1.98		0.28	11/16	
	3/4	-600-R-12	1.98		0.28	13/16	
1/2	1/4	-810-R-4	1.77	0.90	0.17	13/16	—
	3/8	-810-R-6	1.84		0.27	13/16	
	1/2	-810-R-8	2.06		0.37	13/16	
	5/8	-810-R-10	2.12		0.41	13/16	
	3/4	-810-R-12	2.12		0.41	13/16	
5/8	3/4	-1010-R-12	2.15	0.96	0.50	15/16	—
	7/8	-1010-R-14	2.21		15/16		
	1	-1010-R-16	2.40		1 1/16		
3/4	1/2	-1210-R-8	2.15	0.96	0.37	1 1/16	—
	1	-1210-R-16	2.46		0.62	—	
1	1 1/4	-1610-R-20 ^①	3.17	1.23	0.88	1 3/8	1 7/8
	1 1/2	-1610-R-24 ^①	3.51		1 5/8	2 1/4	
	2	-1610-R-32 ^①	4.43		2 1/8	3	
1 1/4	1 1/2	-2000-R-24 ^①	4.10	1.62	1.09	1 3/4	2 1/4
	2	-2000-R-32 ^①	4.93		2 1/8	3	
1 1/2	2	-2400-R-32 ^①	5.17	1.97	1.34	2 1/8	3

① Furnished with nut and preswaged ferrules.

Reducer (Metric)

Tube OD		Basic Ordering Number	Dimensions			
T	Tx		A	D	E	F
Dimensions, mm						
2	3	-2M0-R-3M	33.5	12.9	1.7	12
3	4	-3M0-R-4M	35.0	12.9	2.4	12
	6	-3M0-R-6M	36.1			14
4	6	-3M0-R-10M	38.4	13.7	2.4	12
	6	-4M0-R-6M	37.1			14
6	3	-6M0-R-3M	36.9	15.3	1.9	14
	8	-6M0-R-8M	39.9		4.8	14
	10	-6M0-R-10M	40.7		4.8	14
	12	-6M0-R-12M	46.3		4.8	14
6	18	-6M0-R-18M	49.6	4.8	22	
	8	-8M0-R-6M	40.3		16.2	4.1
8	10	-8M0-R-10M	42.0	6.4		
	12	-8M0-R-12M	47.6	6.4		
10	6	-10M0-R-6M	42.4	17.2	4.1	18
	8	-10M0-R-8M	43.4		5.6	18
	12	-10M0-R-12M	49.8		7.9	18
	15	-10M0-R-15M	51.3		7.9	18
	18	-10M0-R-18M	51.3		7.9	22
12	6	-12M0-R-6M	44.9	22.8	4.1	22
	8	-12M0-R-8M	45.9		5.6	22
	10	-12M0-R-10M	46.7		7.1	22
	16	-12M0-R-16M	53.8		9.5	22
	18	-12M0-R-18M	53.8		9.5	22
	20	-12M0-R-20M	56.1		9.5	22
	22	-12M0-R-22M	56.1		9.5	24
25	-12M0-R-25M	62.4	9.5	27		
14	12	-14M0-R-12M	53.0	24.4	8.8	24
15	12	-15M0-R-12M	53.0	24.4	8.8	24
16	12	-16M0-R-12M	53.0	24.4	8.8	24
18	12	-18M0-R-12M	54.6	24.4	8.8	27
	16	-18M0-R-16M	56.1		12.0	
	20	-18M0-R-20M	57.6		15.1	
	22	-18M0-R-22M	57.6		15.1	
	25	-18M0-R-25M	62.4		15.1	
20	16	-20M0-R-16M	57.9	26.0	12.0	30
	18	-20M0-R-18M	57.9		13.9	
	22	-20M0-R-22M	59.4		15.9	
	25	-20M0-R-25M	64.2		15.9	
22	18	-22M0-R-18M	57.9	26.0	13.9	30
	20	-22M0-R-20M	59.4		15.5	
	25	-22M0-R-25M	64.2		18.3	
25	18	-25M0-R-18M	63.1	31.3	13.9	35
	20	-25M0-R-20M	64.6		15.5	

Refer to Installation Instructions, beginning on page 69.

Straight Fittings

Reducers

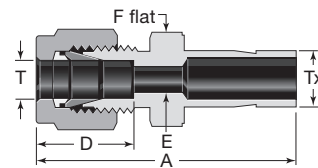
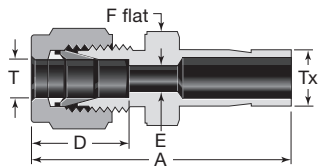

Reducer (Metric to Fractional)

Tube OD		Basic Ordering Number	Dimensions			
T	Tx, in.		A	D	E	F
Dimensions, mm						
2	1/8	-2M0-R-2	33.5	12.9	1.7	12
3	1/8	-3M0-R-2	33.5	12.9	2.0	12
	1/4	-3M0-R-4	36.1		2.4	
4	1/4	-4M0-R-4	37.1	13.7	2.4	12
6	1/8	-6M0-R-2	36.9	15.3	2.0	14
	1/4	-6M0-R-4	39.2		4.4	
	5/16	-6M0-R-5	39.9		4.8	
	3/8	-6M0-R-6	40.7		4.8	
	1/2	-6M0-R-8	46.3		4.8	
8	1/4	-8M0-R-4	40.3	16.2	4.4	15
	3/8	-8M0-R-6	42.0		6.4	
	1/2	-8M0-R-8	47.6		6.4	
10	3/8	-10M0-R-6	44.2	17.2	6.8	18
	1/2	-10M0-R-8	49.8		7.9	
12	1/2	-12M0-R-8	52.3	22.8	9.3	22
	3/4	-12M0-R-12	53.8		9.5	
18	3/4	-18M0-R-12	56.1	24.4	14.7	27
	1	-18M0-R-16	62.4		15.1	
25	1	-25M0-R-16	69.5	31.3	20.2	35

Reducer (Fractional to Metric)

Tube OD		Basic Ordering Number	Dimensions			
T	Tx, mm		A	D	E	F
Dimensions, in.						
1/8	6	-200-R-6M	1.42	0.50	0.09	7/16

Long Reducer

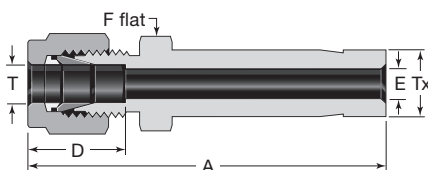

Tube OD		Basic Ordering Number	Dimensions			
T	Tx		A	D	E	F
Dimensions, in.						
3/8	1/2	-600-RF-8	2.57	0.66	0.25	5/8

Use only long reducers in female Swagelok end connections.

Bulkhead Reducer

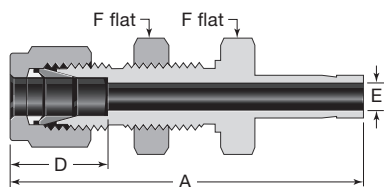

Tube OD	Basic Ordering Number	Dimensions					
		A	D	E	F	Panel Hole Size	Max Panel Thickness
Dimensions, in.							
1/8	-200-R1-2	1.95	0.50	0.08	1/2	21/64	0.50
1/4	-400-R1-4	2.20	0.60	0.17	5/8	29/64	0.40
3/8	-600-R1-6	2.41	0.66	0.27	3/4	37/64	0.44
1/2	-810-R1-8	2.87	0.90	0.37	15/16	49/64	0.50
5/8	-1010-R1-10	2.96	0.96	0.47	1 1/16	57/64	0.50
3/4	-1210-R1-12	3.21	0.96	0.58	1 3/16	1 1/64	0.66
1	-1610-R1-16	3.95	1.23	0.80	1 5/8	1 21/64	0.75

Refer to Installation Instructions, beginning on page 69.

Straight Fittings

Port Connectors

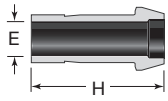

1 in./25 mm and under

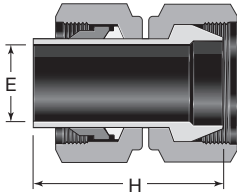

Over 1 in./25 mm

Port Connector

Tube OD	Basic Ordering Number	Dimensions	
		E	H
Dimensions, in.			
1/16	-101-PC	0.03	0.54
1/8	-201-PC	0.08	0.88
1/4	-401-PC	0.17	0.98
5/16	-501-PC	0.22	1.02
3/8	-601-PC	0.27	1.05
1/2	-811-PC	0.37	1.43
5/8	-1011-PC	0.47	1.49
3/4	-1211-PC	0.58	1.49
1	-1611-PC	0.80	1.94
1 1/4	-2000-PC ^①	1.02	2.72
1 1/2	-2400-PC ^①	1.25	3.31
2	-3200-PC ^①	1.72	4.56

① Furnished with nuts and preswaged ferrules.

Tube OD	Basic Ordering Number	Dimensions	
		E	H
Dimensions, mm			
3	-3M1-PC	1.9	22.2
6	-6M1-PC	4.1	25.0
8	-8M1-PC	5.6	26.0
10	-10M1-PC	7.1	27.1
12	-12M1-PC	8.8	36.2
15	-15M1-PC	11.2	37.8
16	-16M1-PC	12.0	37.8
18	-18M1-PC	13.9	37.8
20	-20M1-PC	15.5	39.4
25	-25M1-PC	19.9	49.3
28	B-28M1-PC	22.6	49.0
28	-28M0-PC ^①	22.5	63.5
30	-30M0-PC ^①	24.3	67.6
32	-32M0-PC ^①	26.5	69.7
38	-38M0-PC ^①	31.6	81.9

① Furnished with nuts and preswaged ferrules.

Reducing Port Connector

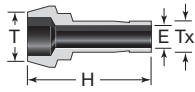

Tube OD		Basic Ordering Number	Dimensions	
T	Tx		E	H
Dimensions, in.				
1/8	1/16	-201-PC-1	0.03	0.72
1/4	1/16	-401-PC-1	0.03	0.75
	1/8	-401-PC-2	0.08	0.90
3/8	1/8	-601-PC-2	0.08	0.92
	1/4	-601-PC-4	0.17	1.00
1/2	1/4	-811-PC-4	0.17	1.17
	3/8	-811-PC-6	0.27	1.21
3/4	1/2	-1211-PC-8	0.37	1.49
1	1/2	-1611-PC-8	0.37	1.69
	3/4	-1611-PC-12	0.58	1.72

Tube OD		Basic Ordering Number	Dimensions	
T	Tx		E	H
Dimensions, mm				
6	3	-6M1-PC-3M	1.9	22.9
8	6	-8M1-PC-6M	4.1	25.4
10	6	-10M1-PC-6M	4.1	25.8
	8	-10M1-PC-8M	5.6	26.3
12	6	-12M1-PC-6M	4.1	29.6
	8	-12M1-PC-8M	5.6	30.1
	10	-12M1-PC-10M	7.1	30.6
16	12	-16M1-PC-12M	8.8	37.5
28	25	-28M1-PC-25M	19.8	56.5
32	25	-32M1-PC-25M	19.8	60.3
38	25	-38M1-PC-25M	19.8	65.8

Refer to Installation Instructions, beginning on page 69.

Straight Fittings

Caps and Plugs

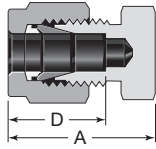

Cap

Tube OD	Basic Ordering Number	A	D
Dimensions, in.			
1/16	-100-C	0.59	0.34
1/8	-200-C	0.79	0.50
3/16	-300-C	0.84	0.54
1/4	-400-C	0.92	0.60
5/16	-500-C	0.96	0.64
3/8	-600-C	1.01	0.66
1/2	-810-C	1.21	0.90
5/8	-1010-C	1.24	0.96
3/4	-1210-C	1.27	0.96
7/8	-1410-C	1.37	1.02
1	-1610-C	1.61	1.23
1 1/8	B-1810-C	1.61	1.23
1 1/4	-2000-C	2.10	1.62
1 1/2	-2400-C	2.54	1.97
2	-3200-C	3.41	2.66

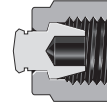

Plug

Tube OD	Basic Ordering Number	A	D
Dimensions, mm			
2	-2M0-C	20.1	12.9
3	-3M0-C	20.1	12.9
4	-4M0-C	21.3	13.7
6	-6M0-C	23.1	15.3
8	-8M0-C	24.5	16.2
10	-10M0-C	26.6	17.2
12	-12M0-C	30.6	22.8
14	-14M0-C	31.4	24.4
15	-15M0-C	31.4	24.4
16	-16M0-C	31.4	24.4
18	-18M0-C	32.2	24.4
20	-20M0-C	34.8	26.0
22	-22M0-C	34.8	26.0
25	-25M0-C	41.0	31.3
28	-28M0-C	48.5	36.6
	B-28M0-C	41.2	31.6
30	-30M0-C	53.4	39.6
32	-32M0-C	55.8	42.0
38	-38M0-C	65.4	49.4

Tube OD	Basic Ordering Number	A	D
Dimensions, in.			
1/16	-100-P		
1/8	-200-P		
3/16	-300-P		
1/4	-400-P		
5/16	-500-P		
3/8	-600-P		
1/2	-810-P		
5/8	-1010-P		
3/4	-1210-P		
7/8	-1410-P		
1	-1610-P		
1 1/4	-2000-P		
1 1/2	-2400-P		
2	-3200-P		

Tube OD	Basic Ordering Number	A	D
Dimensions, mm			
2	-2M0-P		
3	-3M0-P		
4	-4M0-P		
6	-6M0-P		
8	-8M0-P		
10	-10M0-P		
12	-12M0-P		
14	-14M0-P		
15	-15M0-P		
16	-16M0-P		
18	-18M0-P		
20	-20M0-P		
22	-22M0-P		
25	-25M0-P		
28	-28M0-P		
30	-30M0-P		
32	-32M0-P		
38	-38M0-P		

Vent Protectors

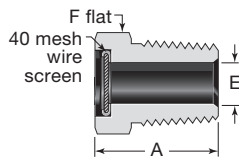

40 mesh 300 series stainless steel wire screen assembly

Mud Dauber

Swagelok vent protectors, more commonly known as **mud dauber fittings**, protect open ends of instruments, tubing, outlet vents, and bleed-off lines.

The mesh wire screen prevents foreign objects, such as mud dauber insects, from entering and clogging various systems and causing damage.

Vent protectors are available in stainless steel and brass. To order brass, replace **SS** in the ordering number with **B**.

Example: **B-MD-2**

NPT Size	Ordering Number	A	E	F
Dimensions, in.				
1/8	SS-MD-2	0.56	0.19	1/2
1/4	SS-MD-4	0.78	0.28	9/16
3/8	SS-MD-6	0.81	0.41	11/16
1/2	SS-MD-8	1.03	0.50	7/8
3/4	SS-MD-12	1.06	0.72	1 1/16

Refer to Installation Instructions, beginning on page 69.

90° Elbows

Unions

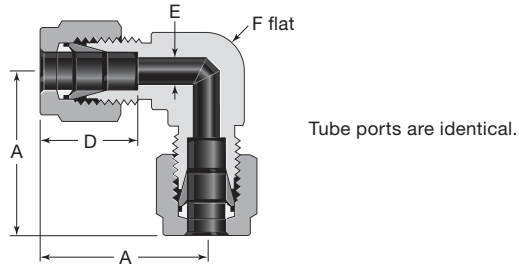

Tube OD	Basic Ordering Number	Dimensions			
		A	D	E	F
Dimensions, in.					
1/16	-100-9	0.70	0.34	0.05	3/8
1/8	-200-9	0.88	0.50	0.09	3/8
3/16	-300-9	1.00	0.54	0.12	1/2
1/4	-400-9	1.06	0.60	0.19	1/2
5/16	-500-9	1.13	0.64	0.25	9/16
3/8	-600-9	1.20	0.66	0.28	5/8
1/2	-810-9	1.42	0.90	0.41	13/16
5/8	-1010-9	1.50	0.96	0.50	15/16
3/4	-1210-9	1.57	0.96	0.62	1 1/16
7/8	-1410-9	1.76	1.02	0.72	1 3/8
1	-1610-9	1.93	1.23	0.88	1 3/8
1 1/8	B-1810-9	2.17	1.23	0.97	1 11/16
1 1/4	-2000-9	2.67	1.62	1.09	1 11/16
1 1/2	-2400-9	3.10	1.97	1.34	2
2	-3200-9	4.22	2.66	1.81	2 3/4

Tube OD	Basic Ordering Number	Dimensions			
		A	D	E	F, in.
Dimensions, mm					
3	-3M0-9	22.3	12.9	2.4	3/8
4	-4M0-9	25.4	13.7	2.4	1/2
6	-6M0-9	27.0	15.3	4.8	1/2
8	-8M0-9	28.8	16.2	6.4	9/16
10	-10M0-9	31.5	17.2	7.9	11/16
12	-12M0-9	36.0	22.8	9.5	13/16
14	-14M0-9	38.0	24.4	11.1	15/16
15	-15M0-9	38.0	24.4	11.9	15/16
16	-16M0-9	38.0	24.4	12.7	15/16
18	-18M0-9	39.8	24.4	15.1	1 1/16
20	-20M0-9	44.6	26.0	15.9	1 3/8
22	-22M0-9	44.6	26.0	18.3	1 3/8
25	-25M0-9	49.1	31.3	21.8	1 3/8
28	-28M0-9	64.0	36.6	21.8	41 mm
	B-28M0-9	55.4	31.6	24.6	1 11/16
30	-30M0-9	69.9	39.6	26.2	46 mm
32	-32M0-9	72.3	42.0	28.6	46 mm
38	-38M0-9	84.0	49.4	33.7	55 mm
50	-50M0-9	106	65.0	45.2	2 3/4

Refer to Installation Instructions, beginning on page 69.

90° Elbows

Male

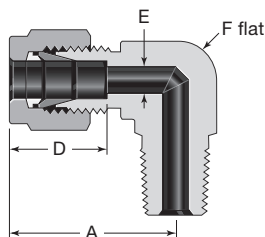

See page 9 for thread specifications.

NPT

Tube OD	NPT Size	Basic Ordering Number	Dimensions			
			A	D	E ^①	F
Dimensions, in.						
1/16	1/16 1/8	-100-2-1 -100-2-2	0.75	0.34	0.05	7/16
1/8	1/16	-200-2-1	0.93	0.50	0.09	7/16
	1/8	-200-2-2	0.93			7/16
	1/4	-200-2-4	0.97			1/2
3/16	1/8	-300-2-2	1.00	0.54	0.12	1/2
	1/4	-300-2-4				
1/4	1/16	-400-2-1	1.06	0.60	0.12	1/2
	1/8	-400-2-2	1.06		0.19	1/2
	1/4	-400-2-4	1.06		0.19	1/2
	3/8	-400-2-6	1.17		0.19	11/16
	1/2	-400-2-8	1.25		0.19	13/16
5/16	1/8	-500-2-2	1.13	0.64	0.19	9/16
	1/4	-500-2-4	1.13		0.25	9/16
	3/8	-500-2-6	1.20		0.25	11/16
3/8	1/8	-600-2-2	1.20	0.66	0.19	5/8
	1/4	-600-2-4	1.20		0.28	5/8
	3/8	-600-2-6	1.23		0.28	11/16
	1/2	-600-2-8	1.31		0.28	13/16
	3/4	-600-2-12	1.46		0.28	1 1/16
1/2	1/4	-810-2-4	1.42	0.90	0.28	13/16
	3/8	-810-2-6	1.42		0.38	13/16
	1/2	-810-2-8	1.42		0.41	13/16
	3/4	-810-2-12	1.57		0.41	1 1/16
5/8	3/8	-1010-2-6	1.50	0.96	0.38	15/16
	1/2	-1010-2-8	1.50		0.47	15/16
	3/4	-1010-2-12	1.57		0.50	1 1/16
3/4	1/2 3/4	-1210-2-8 -1210-2-12	1.57	0.96	0.47 0.62	1 1/16
7/8	3/4	-1410-2-12	1.76	1.02	0.62	1 3/8
1	3/4 1	-1610-2-12 -1610-2-16	1.93	1.23	0.62 0.88	1 3/8
	1 1/4	1 1/4	-2000-2-20	2.67	1.62	1.09
1 1/2	1 1/2	-2400-2-24	3.10	1.97	1.34	2
2	2	-3200-2-32	4.22	2.66	1.81	2 3/4

① The E dimension is the minimum nominal opening. These fittings may have a larger opening at the pipe/straight thread end.

Tube OD	NPT Size in.	Basic Ordering Number	Dimensions			
			A	D	E ^①	F, in.
Dimensions, mm						
3	1/8	-3M0-2-2	23.6	12.9	2.4	7/16
	1/4	-3M0-2-4	24.6			1/2
4	1/8	-4M0-2-2	25.4	13.7	2.4	1/2
	1/4	-4M0-2-4				
6	1/8	-6M0-2-2	27.0	15.3	4.8	1/2
	1/4	-6M0-2-4	27.0			1/2
	3/8	-6M0-2-6	29.8			11/16
	1/2	-6M0-2-8	31.8			13/16
8	1/8	-8M0-2-2	28.8	16.2	4.8	9/16
	1/4	-8M0-2-4	28.8		6.4	9/16
	3/8	-8M0-2-6	30.6		6.4	11/16
	1/2	-8M0-2-8	32.6		6.4	13/16
10	1/8	-10M0-2-2	31.5	17.2	4.8	11/16
	1/4	-10M0-2-4	31.5		7.1	11/16
	3/8	-10M0-2-6	31.5		7.9	11/16
	1/2	-10M0-2-8	33.5		7.9	13/16
12	1/4	-12M0-2-4	36.0	22.8	7.1	13/16
	3/8	-12M0-2-6	36.0		9.5	13/16
	1/2	-12M0-2-8	36.0		9.5	13/16
	3/4	-12M0-2-12	39.8		9.5	1 1/16
14	1/2	-14M0-2-8	38.0	24.4	11.1	15/16
15	1/2	-15M0-2-8	38.0	24.4	11.9	15/16
16	3/8	-16M0-2-6	38.0	24.4	9.5	15/16
	1/2	-16M0-2-8	38.0		11.9	15/16
	3/4	-16M0-2-12	39.8		12.7	1 1/16
18	1/2	-18M0-2-8	39.8	24.4	11.9	1 1/16
	3/4	-18M0-2-12			15.1	
20	1/2	-20M0-2-8	44.6	26.0	11.9	1 3/8
	3/4	-20M0-2-12			15.9	
22	3/4	-22M0-2-12	44.6	26.0	15.9	1 3/8
	1	-22M0-2-16			18.3	
25	3/4	-25M0-2-12	49.1	31.3	15.9	1 3/8
	1	-25M0-2-16			21.8	
30	1 1/4	-30M0-2-20	69.9	39.6	26.2	46 mm
32	1 1/4	-32M0-2-20	72.3	42.0	27.8	46 mm
38	1 1/2	-38M0-2-24	84.0	49.4	33.7	55 mm

① The E dimension is the minimum nominal opening. These fittings may have a larger opening at the pipe/straight thread end.

Refer to Installation Instructions, beginning on page 69.

90° Elbows

Male

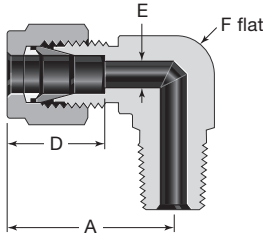

See page 9 for thread specifications.

ISO/BSP Tapered Thread (RT)

Tube OD	ISO Thread Size	Basic Ordering Number	Dimensions				
			A	D	E ^①	F	
Dimensions, in.							
1/8	1/8	-200-2-2RT	0.83	0.50	0.09	7/16	
	1/4	-200-2-4RT	0.97			1/2	
1/4	1/8	-400-2-2RT	1.06	0.60	0.19	1/2	
	1/4	-400-2-4RT	1.06			1/2	
	3/8	-400-2-6RT	1.17			11/16	
	1/2	-400-2-8RT	1.25			13/16	
5/16	1/4	-500-2-4RT	1.13	0.64	0.25	9/16	
3/8	1/8	-600-2-2RT	1.20	0.66	0.28	5/8	
	1/4	-600-2-4RT	1.20			5/8	
	3/8	-600-2-6RT	1.23			11/16	
1/2	1/4	-810-2-4RT	1.42	0.90	0.28	13/16	
	3/8	-810-2-6RT					0.38
	1/2	-810-2-8RT					0.41
		-810-2-8RT					0.41
3/4	1/2	-1210-2-8RT	1.57	0.96	0.47	1 3/8	
1	1	-1610-2-16RT	1.93	1.23	0.88	1 3/8	

① The E dimension is the minimum nominal opening. These fittings may have a larger opening at the pipe/straight thread end.

Tube OD	ISO Thread Size in.	Basic Ordering Number	Dimensions			
			A	D	E ^①	F
Dimensions, mm						
3	1/8	-3M0-2-2RT	23.6	12.9	2.4	7/16
	1/4	-3M0-2-4RT	24.6			1/2
4	1/8	-4M0-2-2RT	25.4	13.7	2.4	1/2
	1/4	-4M0-2-4RT				
6	1/8	-6M0-2-2RT	27.0	15.3	4.8	1/2
	1/4	-6M0-2-4RT	27.0			1/2
	3/8	-6M0-2-6RT	29.8			11/16
	1/2	-6M0-2-8RT	31.8			13/16
8	1/8	-8M0-2-2RT	28.8	16.2	4.8	9/16
	1/4	-8M0-2-4RT	28.8			9/16
	3/8	-8M0-2-6RT	30.6			11/16
	1/2	-8M0-2-8RT	32.6			13/16
10	1/4	-10M0-2-4RT	31.5	17.2	7.1	11/16
	3/8	-10M0-2-6RT	31.5			11/16
	1/2	-10M0-2-8RT	33.5			13/16
12	1/8	-12M0-2-2RT	36.0	22.8	4.8	13/16
	1/4	-12M0-2-4RT	36.0			13/16
	3/8	-12M0-2-6RT	36.0			13/16
	1/2	-12M0-2-8RT	36.0			13/16
	3/4	-12M0-2-12RT	39.8			1 1/16
14	1/2	-14M0-2-8RT	38.1	24.4	11.1	15/16
15	1/2	-15M0-2-8RT	38.1	24.4	11.9	15/16
16	3/8	-16M0-2-6RT	38.0	24.4	9.5	15/16
	1/2	-16M0-2-8RT			11.9	
18	1/2	-18M0-2-8RT	39.8	24.4	11.9	1 1/16
	3/4	-18M0-2-12RT			15.1	
20	1/2	-20M0-2-8RT	44.6	26.0	11.9	1 3/8
	3/4	-20M0-2-12RT			15.9	
22	3/4	-22M0-2-12RT	44.6	26.0	15.9	1 3/8
	1	-22M0-2-16RT			18.3	
25	3/4	-25M0-2-12RT	49.1	31.3	15.9	1 3/8
	1	-25M0-2-16RT			21.8	
28	1	-28M0-2-16RT	64.0	36.6	21.8	41 mm
	1	B-28M0-2-16RT	55.4	31.6	22.2	

① The E dimension is the minimum nominal opening. These fittings may have a larger opening at the pipe/straight thread end.

Refer to Installation Instructions, beginning on page 69.

90° Elbows

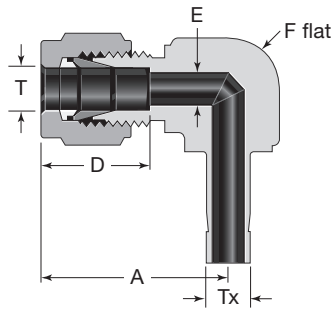

Reducing Elbows

Tube OD		Basic Ordering Number	Dimensions			
T	Tx		A	D	E	F, in.
Dimensions, in.						
1/4	1/4	-400-2R-4	1.06	0.60	0.17	1/2
3/8		-600-2R-4	1.20	0.66	0.17	5/8
3/8	3/8	-600-2R-6	1.20	0.66	0.27	5/8
1/2		-810-2R-6	1.42	0.90	0.27	13/16
1/2	1/2	-810-2R-8	1.42	0.90	0.37	13/16
Dimensions, mm						
6	6	-6M0-2R-6M	27.0	15.3	4.6	1/2
12	12	-12M0-2R-12M	38.1	22.8	8.8	15/16

valvesgo.com

90° Elbows

Male

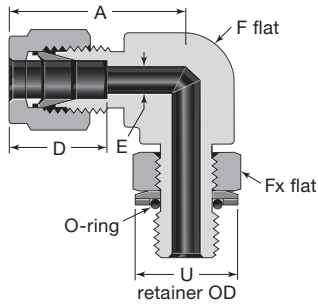

Positionable, ISO/BSP Parallel Thread (PR)

Tube OD	ISO Thread Size in.	Basic Ordering Number	Dimensions					
			A	D	E ^①	F, in.	Fx, in.	U
Dimensions, in.								
1/4	1/8 1/4	-400-2-2PR -400-2-4PR	1.06 1.14	0.60	0.16 0.19	1/2 5/8	9/16 3/4	0.60 0.80
3/8	1/4 3/8	-600-2-4PR -600-2-6PR	1.20 1.31	0.66	0.23 0.28	5/8 13/16	3/4 7/8	0.80 0.96
1/2	1/4	-810-2-4PR	1.42	0.90	0.23	13/16	3/4	0.80
	3/8	-810-2-6PR	1.42		0.31	13/16	7/8	0.96
	1/2	-810-2-8PR	1.50		0.41	15/16	1 1/16	1.16
5/8	1/2	-1010-2-8PR	1.50	0.96	0.47	15/16	1 1/16	1.16
3/4	1/2	-1210-2-8PR	1.57	0.96	0.47 0.62	1 1/16	1 1/16	1.16
	3/4	-1210-2-12PR					1 3/8	1.43
1	3/4	-1610-2-12PR	1.93	1.23	0.62 0.78	1 3/8	1 3/8	1.43
	1	-1610-2-16PR					1 5/8	1.82
Dimensions, mm								
6	1/8 1/4	-6M0-2-2PR -6M0-2-4PR	27.0 29.0	15.3	4.0 4.8	1/2 5/8	9/16 3/4	15.2 20.3
	8	1/8 1/4	-8M0-2-2PR -8M0-2-4PR		28.8 29.9	16.2	4.0 5.9	9/16 5/8
10		1/4 3/8	-10M0-2-4PR -10M0-2-6PR	33.5	17.2	5.9 7.9	13/16	3/4 7/8
	12	1/4	-12M0-2-4PR	36.0		22.8	5.9	13/16
3/8		-12M0-2-6PR	36.0	7.9	13/16		7/8	24.4
1/2		-12M0-2-8PR	38.0	9.5	15/16		1 1/16	29.5
3/4		-12M0-2-12PR	39.8	9.5	1 1/16		1 3/8	36.3

① The E dimension is the minimum nominal opening. These fittings may have a larger opening at the pipe/straight thread end.

Positionable, SAE/MS Straight Thread (ST)

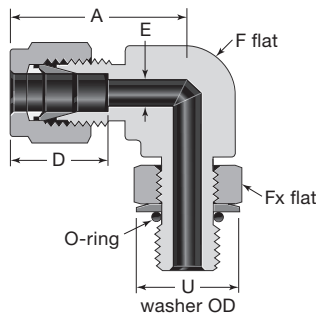

SAE/MS positionable fittings are available in carbon steel and stainless steel only. Adapts to SAE J1926/1 and ISO 11926-1 straight thread boss.

Tube OD	SAE/MS Thread Size	Basic Ordering Number	Dimensions					
			A	D	E ^①	F, in.	Fx, in.	U
Dimensions, in.								
1/4	7/16-20 9/16-18	-400-2-4ST -400-2-6ST	1.12 1.20	0.60	0.19	1/2	9/16	0.65
	5/16	1/2-20	-500-2-5ST			1.19	0.64	0.23
3/8	7/16-20	-600-2-4ST	1.26	0.66	0.20 0.28 0.28	5/8	9/16	0.65
	9/16-18	-600-2-6ST	1.26			5/8	11/16	0.79
	3/4-16	-600-2-8ST	1.37			13/16	7/8	1.01
1/2	9/16-18 3/4-16	-810-2-6ST -810-2-8ST	1.48	0.90	0.28 0.41	13/16	11/16 7/8	0.79 1.01
	5/8	7/8-14	-1010-2-10ST		1.56	0.96	0.50	15/16
3/4	1 1/16-12	-1210-2-12ST	1.63	0.96	0.62	1 1/16	1 1/4	1.44
7/8	1 3/16-12	-1410-2-14ST	1.70	1.02	0.72	1 3/16	1 3/8	1.59
1	1 5/16-12	-1610-2-16ST	1.99	1.23	0.88	1 3/8	1 1/2	1.73
1 1/4	1 5/8-12	-2000-2-20ST	2.67	1.62	1.09	1 11/16	1 7/8	2.16
1 1/2	1 7/8-12	-2400-2-24ST	3.07	1.97	1.34	2	2 1/8	2.45
2	2 1/2-12	-3200-2-32ST	4.22	2.66	1.81	2 3/4	2 3/4	3.16

① The E dimension is the minimum nominal opening. These fittings may have a larger opening at the pipe/straight thread end.

For ST and ST positionable fittings used in ECE-R110 applications, add the **DE** O-ring suffix to the ordering number. Example: SS-600-2-6ST**DE**

Refer to Installation Instructions, beginning on page 69.

90° Elbows

Weld

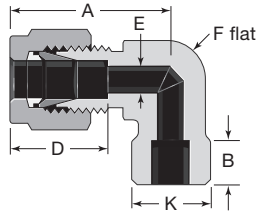

Tube Socket Weld

Tube OD	Socket Weld Size	Basic Ordering Number	Dimensions					
			A	B	D	E	F	K
Dimensions, in.								
1/4	1/4	-400-9-4W	1.06	0.28	0.60	0.19	1/2	0.50
3/8	3/8	-600-9-6W	1.20	0.31	0.66	0.28	5/8	0.63
1/2	1/2	-810-9-8W	1.42	0.38	0.90	0.41	13/16	0.81
3/4	3/4	-1210-9-12W	1.57	0.44	0.96	0.62	1 1/16	1.06
1	1	-1610-9-16W	1.93	0.62	1.23	0.88	1 3/8	1.38

Male Pipe Weld

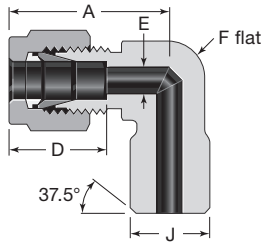

Tube OD	Pipe Weld Size	Basic Ordering Number	Dimensions				
			A	D	E ^①	F	J
Dimensions, in.							
1/4	1/8 1/4	-400-2-2W -400-2-4W	1.06	0.60	0.19	1/2	0.405 0.540
3/8	1/4	-600-2-4W	1.20	0.66	0.28	5/8	0.540
1/2	1/2	-810-2-8W	1.42	0.90	0.41	13/16	0.840
3/4	3/4	-1210-2-12W	1.57	0.96	0.62	1 1/16	1.050

① The E dimension is the minimum nominal opening. These fittings may have a larger opening at the weld end. Wall thickness at the weld end is based on schedule 80 pipe.

Female

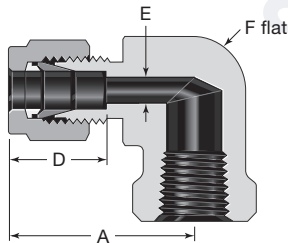

NPT

Tube OD	NPT Size	Basic Ordering Number	Dimensions			
			A	D	E	F
Dimensions, in.						
1/8	1/8 1/4	-200-8-2 -200-8-4	0.97 1.08	0.50	0.09	1/2 11/16
3/16	1/8	-300-8-2	1.00	0.54	0.12	1/2
1/4	1/8	-400-8-2	1.06	0.60	0.19	1/2
	1/4	-400-8-4	1.17			11/16
	3/8	-400-8-6	1.25			13/16
	1/2	-400-8-8	1.36			1
5/16	1/8	-500-8-2	1.13	0.64	0.25	9/16
	1/4	-500-8-4	1.20			11/16
3/8	1/8	-600-8-2	1.20	0.66	0.28	5/8
	1/4	-600-8-4	1.23			11/16
	3/8	-600-8-6	1.31			13/16
	1/2	-600-8-8	1.42			1
1/2	1/4	-810-8-4	1.42	0.90	0.41	13/16
	3/8	-810-8-6	1.42			13/16
	1/2	-810-8-8	1.53			1
5/8	3/8	-1010-8-6	1.50	0.96	0.50	15/16
	1/2	-1010-8-8	1.57			1 1/16
3/4	1/2	-1210-8-8	1.57	0.96	0.62	1 1/16
	3/4	-1210-8-12	1.76			1 3/8
7/8	3/4	-1410-8-12	1.76	1.02	0.72	1 3/8
	1	1	-1610-8-12 -1610-8-16	1.93 2.11	1.23	0.88

Tube OD	NPT Size in.	Basic Ordering Number	Dimensions			
			A	D	E	F, in.
Dimensions, mm						
6	1/8	-6M0-8-2	27.0	15.3	4.8	1/2
	1/4	-6M0-8-4	29.8			11/16
	1/2	-6M0-8-8	34.6			1
8	1/4	-8M0-8-4	30.6	16.2	6.4	11/16
10	1/8	-10M0-8-2	31.5	17.2	7.9	11/16
	1/4	-10M0-8-4	33.5			13/16
12	1/4	-12M0-8-4	36.0	22.8	9.5	13/16
	1/2	-12M0-8-8	38.8			1
16	1/2	-16M0-8-8	39.5	24.4	12.7	1 1/16

Refer to Installation Instructions, beginning on page 69.

45° Elbows

Male

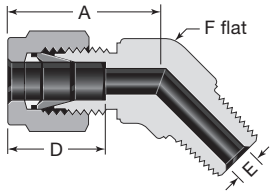

NPT

Tube OD	NPT Size	Basic Ordering Number	Dimensions			
			A	D	E ^①	F
Dimensions, in.						
1/4	1/8 1/4	-400-5-2 -400-5-4	0.97	0.60	0.19	1/2
3/8	1/8	-600-5-2	1.10	0.66	0.19	5/8
	1/4	-600-5-4	1.10		0.28	5/8
	3/8	-600-5-6	1.15		0.28	13/16
1/2	3/8	-810-5-6	1.26	0.90	0.38	13/16
	1/2	-810-5-8			0.41	
3/4	3/4	-1210-5-12	1.33	0.96	0.62	1 1/16
1	1	-1610-5-16	1.59	1.23	0.88	1 3/8

① The E dimension is the minimum nominal opening. These fittings may have a larger opening at the pipe/straight thread end.

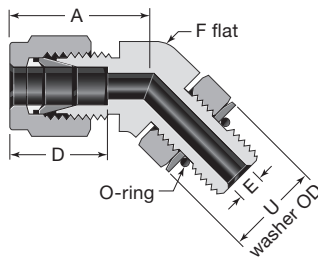

Positionable, SAE/MS Straight Thread (ST)

Tube OD	SAE/MS Thread Size	Basic Ordering Number	Dimensions				
			A	D	E ^①	F	U
Dimensions, in.							
1/4	7/16-20	-400-5-4ST	1.01	0.60	0.19	1/2	0.65
3/8	9/16-18	-600-5-6ST	1.10	0.66	0.28	5/8	0.79
1/2	3/4-16	-810-5-8ST	1.26	0.90	0.41	13/16	1.01
3/4	1 1/16-12	-1210-5-12ST	1.33	0.96	0.62	1 1/16	1.44
1	1 5/16-12	-1610-5-16ST	1.59	1.23	0.88	1 3/8	1.73

① The E dimension is the minimum nominal opening. These fittings may have a larger opening at the pipe/straight thread end.

SAE/MS positionable fittings are available in carbon steel and stainless steel only.

Adapts to SAE J1926/1 and ISO 11926-1 straight thread boss.

Refer to Installation Instructions, beginning on page 69.

Tees

Unions

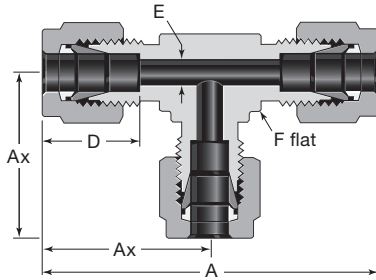

Union

Tube OD	Basic Ordering Number	Dimensions				
		A	Ax	D	E	F
Dimensions, in.						
1/16	-100-3	1.40	0.70	0.34	0.05	3/8
1/8	-200-3	1.76	0.88	0.50	0.09	3/8
3/16	-300-3	1.92	0.96	0.54	0.12	7/16
1/4	-400-3	2.12	1.06	0.60	0.19	1/2
5/16	-500-3	2.34	1.17	0.64	0.25	5/8
3/8	-600-3	2.40	1.20	0.66	0.28	5/8
1/2	-810-3	2.84	1.42	0.90	0.41	13/16
5/8	-1010-3	3.06	1.53	0.96	0.50	1
3/4	-1210-3	3.14	1.57	0.96	0.62	1 1/16
7/8	-1410-3	3.52	1.76	1.02	0.72	1 3/8
1	-1610-3	3.86	1.93	1.23	0.88	1 3/8
1 1/8	B-1810-3	4.34	2.17	1.23	0.97	1 11/16
1 1/4	-2000-3	5.34	2.67	1.62	1.09	1 11/16
1 1/2	-2400-3	6.20	3.10	1.97	1.34	2
2	-3200-3	8.44	4.22	2.66	1.81	2 3/4

Tube OD	Basic Ordering Number	Dimensions				
		A	Ax	D	E	F, in.
Dimensions, mm						
2	-2M0-3	44.7	22.3	12.9	1.7	3/8
3	-3M0-3	44.7	22.3	12.9	2.4	3/8
4	-4M0-3	50.8	25.4	13.7	2.4	1/2
6	-6M0-3	53.9	27.0	15.3	4.8	1/2
8	-8M0-3	59.7	29.9	16.2	6.4	5/8
10	-10M0-3	63.0	31.5	17.2	7.9	11/16
12	-12M0-3	72.0	36.0	22.8	9.5	13/16
14	-14M0-3	77.6	38.8	24.4	11.1	1
15	-15M0-3	77.6	38.8	24.4	11.9	1
16	-16M0-3	77.6	38.8	24.4	12.7	1
18	-18M0-3	79.6	39.8	24.4	15.1	1 1/16
20	-20M0-3	89.3	44.6	26.0	15.9	1 3/8
22	-22M0-3	89.3	44.6	26.0	18.3	1 3/8
25	-25M0-3	98.3	49.1	31.3	21.8	1 3/8
28	-28M0-3	128	64.0	36.6	21.8	41 mm
	B-28M0-3	103	51.4	31.6	24.6	1 11/16
30	-30M0-3	140	69.9	39.6	26.2	46 mm
32	-32M0-3	145	72.3	42.0	28.6	46 mm
38	-38M0-3	168	84.0	49.4	33.7	55 mm
50	-50M0-3	211	106	65.0	45.2	2 3/4

Reducing Union (Fractional)

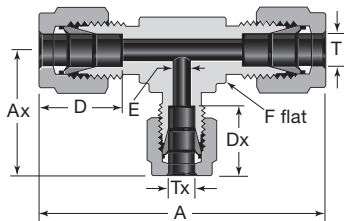

Tube OD		Basic Ordering Number	Dimensions					
T	Tx		A	Ax	D	Dx	E	F
Dimensions, in.								
3/8	1/4	-600-3-6-4	2.40	1.14	0.66	0.60	0.19	5/8
1/2	1/4	-810-3-8-4	2.84	1.25	0.90	0.60	0.19	13/16
	3/8	-810-3-8-6		1.31		0.66	0.28	
5/8	3/8	-1010-3-10-6	3.06	1.42	0.96	0.66	0.28	1
3/4	3/8	-1210-3-12-6	3.14	1.46	0.96	0.66	0.28	1 1/16
	1/2	-1210-3-12-8		1.57		0.90	0.41	
1	3/8	-1610-3-16-6	3.86	1.65	1.23	0.66	0.28	1 3/8
	1/2	-1610-3-16-8		1.76		0.90	0.41	
	3/4	-1610-3-16-12		1.76		0.96	0.62	
1 1/4	1	-2000-3-20-16	5.34	2.17	1.62	1.23	0.88	1 11/16
1 1/2	1	-2400-3-24-16	6.20	2.36	1.97	1.23	0.88	2
2	1	-3200-3-32-16	8.44	2.79	2.66	1.23	0.88	2 3/4

Refer to Installation Instructions, beginning on page 69.

Tees

Unions

Reducing Union (Metric)

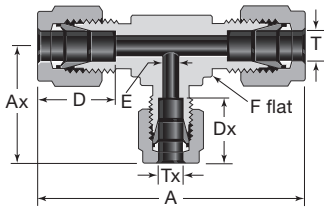

Tube OD		Basic Ordering Number	Dimensions					
T	Tx		A	Ax	D	Dx	E	F, in.
Dimensions, mm								
3	6	-3M0-3-3M-6M	49.3	26.9	12.9	15.3	2.4	1/2
8		-8M0-3-8M-6M	59.9	29.0	16.2	15.3	4.8	5/8
10		-10M0-3-10M-6M	63.0	29.7	17.2	15.3	4.8	11/16
12		-12M0-3-12M-6M	72.0	31.8	22.8	15.3	4.8	13/16
15	12	-15M0-3-15M-12M	77.7	38.9	24.4	22.8	9.5	1
16		-16M0-3-16M-12M	77.6	38.9	24.4	22.8	9.5	1
18		-18M0-3-18M-12M	79.8	39.9	24.4	22.8	9.5	1 1/16
22		-22M0-3-22M-12M	89.4	44.7	26.0	22.8	9.5	1 3/8
25		-25M0-3-25M-12M	98.0	44.7	31.3	22.8	9.5	1 3/8

Reducing Union

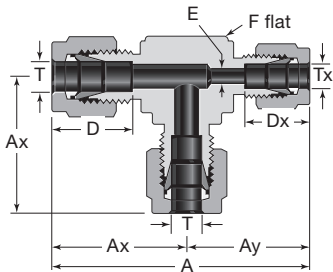

Tube OD		Basic Ordering Number	Dimensions						
T	Tx		A	Ax	Ay	D	Dx	E	F
Dimensions, in.									
3/8	1/4	-600-3-4-6	2.34	1.20	1.14	0.66	0.60	0.19	5/8

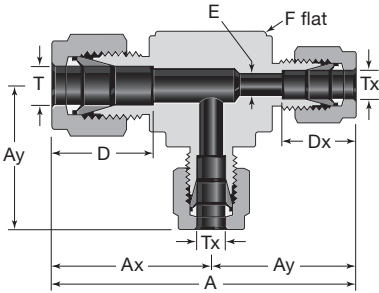

Tube OD		Basic Ordering Number	Dimensions						
T	Tx		A	Ax	Ay	D	Dx	E	F
Dimensions, in.									
1/2	3/8	-810-3-6-6	2.73	1.42	1.31	0.90	0.66	0.28	13/16
5/8		-1010-3-6-6	2.95	1.53	1.42	0.96	0.66	0.28	1
3/4		-1210-3-6-6	3.03	1.57	1.46	0.96	0.66	0.28	1 1/16

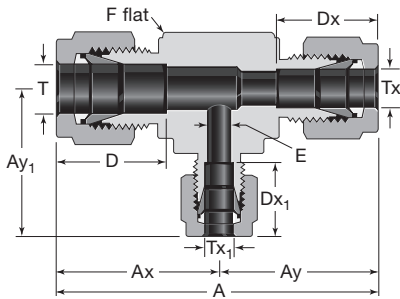

Tube OD			Basic Ordering Number	Dimensions								
T	Tx	Tx1		A	Ax	Ay	Ay1	D	Dx	Dx1	E	F
Dimensions, in.												
5/8	1/2	3/8	-1010-3-8-6	3.06	1.53	1.53	1.42	0.96	0.90	0.66	0.28	1
3/4	1/2		-1210-3-8-6	3.14	1.57	1.57	1.46	0.96	0.90			1 1/16
1	3/4		-1610-3-12-6	3.69	1.93	1.76	1.65	1.23	0.96			1 3/8

Refer to Installation Instructions, beginning on page 69.

Tees

Male

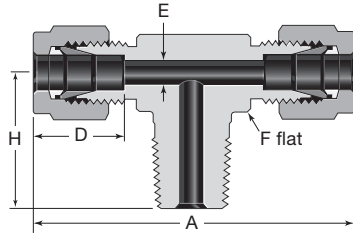

Branch, NPT (TTM)

Tube OD	NPT Size in.	Basic Ordering Number	Dimensions				
			A	D	E ^①	F, in.	H
Dimensions, in.							
1/8	1/8 1/4	-200-3TTM -200-3-4TTM	1.86 1.94	0.50	0.09	7/16 1/2	0.70 0.92
3/16	1/8	-300-3TTM	1.92	0.54	0.12	7/16	0.70
1/4	1/8 1/4	-400-3TTM -400-3-4TTM	2.12	0.60	0.19	1/2	0.74 0.92
5/16	1/8	-500-3TTM	2.34	0.64	0.19	5/8	0.82
3/8	1/4 3/8	-600-3TTM -600-3-6TTM	2.40 2.62	0.66	0.28	5/8 13/16	1.00 1.11
1/2	3/8 1/2	-810-3TTM -810-3-8TTM	2.84	0.90	0.38 0.41	13/16	1.11 1.30
5/8	1/2	-1010-3TTM	3.06	0.96	0.47	1	1.41
3/4	3/4	-1210-3TTM	3.14	0.96	0.62	1 1/16	1.45
Dimensions, mm							
6	1/8 1/4	-6M0-3TTM -6M0-3-4TTM	53.9	15.3	4.8	1/2	18.8 23.4
8	1/8 1/4	-8M0-3TTM -8M0-3-4TTM	59.7	16.2	4.8 6.4	5/8	20.8 25.4
10	1/4	-10M0-3TTM	67.0	17.2	7.1	13/16	26.2
12	3/8 1/4 1/2	-12M0-3TTM -12M0-3-4TTM -12M0-3-8TTM	72.0	22.8	9.5 7.1 9.5	13/16	28.2 28.2 33.0
16	1/2	-16M0-3TTM	77.6	24.4	11.9	1	35.8

① The E dimension is the minimum nominal opening. These fittings may have a larger opening at the pipe/straight thread end.

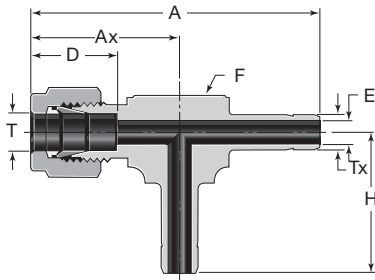

Adapter Tees

Tube OD		Basic Ordering Number	Dimensions					
T	Tx		A	Ax	D	E	F	H
Dimensions, in.								
1/4	1/4	-400-3-4TAA	2.06	1.00	0.60	0.17	1/2	1.00
3/8		-600-3-4TAA	2.28	1.08	0.66	0.17	5/8	1.08
3/8	3/8	-600-3-6TAA	2.34	1.14	0.66	0.27	5/8	1.14
1/2		-810-3-6TAA	2.67	1.25	0.90	0.27	13/16	1.25
1/2	1/2	-810-3-8TAA	3.09	1.59	0.90	0.37	15/16	1.59

Refer to Installation Instructions, beginning on page 69.

Tees

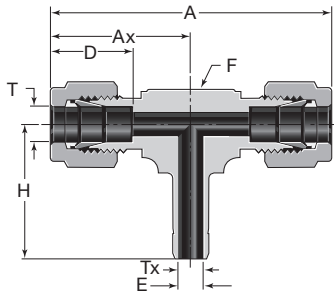

Adapter Branch Tees

Tube OD		Basic Ordering Number	Dimensions					
T	Tx		A	Ax	D	E	F	H
Dimensions, in.								
1/4	1/4	-400-3-4TTA	2.12	1.06	0.60	0.17	1/2	1.00
3/8	3/8	-600-3-6TTA	2.40	1.20	0.66	0.27	5/8	1.14
1/2	1/2	-810-3-8TTA	3.00	1.50	0.90	0.37	15/16	1.59

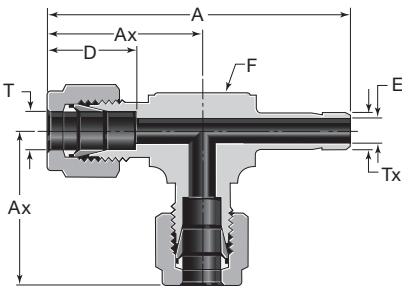

Adapter Run Tees

Tube OD		Basic Ordering Number	Dimensions				
T	Tx		A	Ax	D	E	F
Dimensions, in.							
1/4	1/4	-400-3-4TAT	2.06	1.06	0.60	0.17	1/2
3/8		-600-3-4TAT	2.28	1.20	0.66	0.17	5/8
3/8	3/8	-600-3-6TAT	2.34	1.20	0.66	0.27	5/8
1/2		-810-3-6TAT	2.67	1.42	0.90	0.27	13/16
1/2	1/2	-810-3-8TAT	3.09	1.50	0.90	0.37	15/16

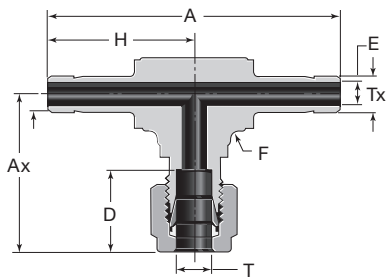

Double Run Adapter Tees

Tube OD		Basic Ordering Number	Dimensions					
T	Tx		A	Ax	D	E	F	H
Dimensions, in.								
1/4	1/4	-400-3-4AAT	2.14	1.16	0.60	0.17	1/2	1.07
3/8	3/8	-600-3-6AAT	2.66	1.39	0.66	0.27	13/16	1.33
1/2	1/2	-810-3-8AAT	3.66	1.74	0.90	0.37	1 1/4	1.83

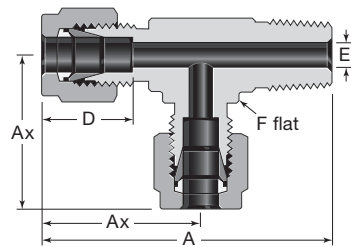

Run, NPT (TMT)

Tube OD	NPT Size in.	Basic Ordering Number	Dimensions				
			A	Ax	D	E ^①	F, in.
Dimensions, in.							
1/8	1/8	-200-3TMT	1.63	0.93	0.50	0.09	7/16
	1/4	-200-3-4TMT	1.89	0.97	0.50	0.09	1/2
3/16	1/8	-300-3TMT	1.66	0.96	0.54	0.12	7/16
1/4	1/8	-400-3TMT	1.80	1.06	0.60	0.19	1/2
	1/4	-400-3-4TMT	1.98				
5/16	1/8	-500-3TMT	1.99	1.17	0.64	0.19	5/8
	3/8	-600-3TMT	2.20	1.20	0.66	0.28	5/8
3/8	-600-3-6TMT	2.42	1.31				
1/2	3/8	-810-3TMT	2.53	1.42	0.90	0.38	13/16
	1/2	-810-3-8TMT	2.72				
5/8	1/2	-1010-3TMT	2.88	1.50	0.96	0.47	15/16
3/4	3/4	-1210-3TMT	3.02	1.57	0.96	0.62	1 1/16
Dimensions, mm							
6	1/8	-6M0-3TMT	45.8	27.0	15.3	4.8	1/2
	1/4	-6M0-3-4TMT	50.3				
8	1/4	-8M0-3-4TMT	55.3	29.9	16.2	6.4	5/8
12	1/4	-12M0-3-4TMT	64.2	36.0	22.8	7.1	13/16
	1/2	-12M0-3-8TMT	69.0				
16	1/2	-16M0-3TMT	73.1	38.0	24.4	11.9	15/16

① The E dimension is the minimum nominal opening. These fittings may have a larger opening at the pipe/straight thread end.

Tees

Male

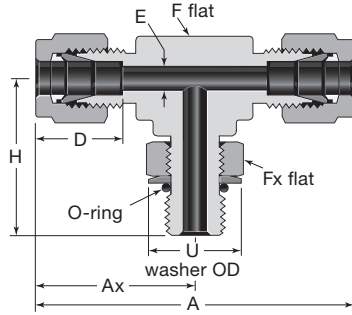

SAE/MS positionable fittings are available in carbon steel and stainless steel only.

Adapts to SAE J1926/1 and ISO 11926-1 straight thread boss.

Positionable Branch, SAE/MS Straight Thread (TTS)

Tube OD	SAE/MS Thread Size	Basic Ordering Number	Dimensions							
			A	Ax	D	E ^①	F	Fx	H	U
Dimensions, in.										
1/4	7/16-20	-400-3TTS	2.24	1.12	0.60	0.19	1/2	9/16	1.12	0.65
3/8	9/16-18	-600-3TTS	2.52	1.26	0.66	0.28	5/8	11/16	1.27	0.79
1/2	3/4-16	-810-3TTS	2.96	1.48	0.90	0.41	13/16	7/8	1.49	1.01
3/4	1 1/16-12	-1210-3TTS	3.26	1.63	0.96	0.62	1 1/16	11/4	1.92	1.44
1	1 5/16-12	-1610-3TTS	3.98	1.99	1.23	0.88	1 3/8	1 1/2	2.11	1.73
1 1/4	1 5/8-12	-2000-3TTS	5.34	2.67	1.62	1.09	1 11/16	1 7/8	2.29	2.16
1 1/2	1 7/8-12	-2400-3TTS	6.14	3.07	1.97	1.34	2	2 1/8	2.45	2.45
2	2 1/2-12	-3200-3TTS	8.44	4.22	2.66	1.81	2 3/4	2 3/4	2.77	3.16

① The E dimension is the minimum nominal opening. These fittings may have a larger opening at the pipe/straight thread end.

Positionable Branch, ISO/BSP Parallel Thread (TTR)

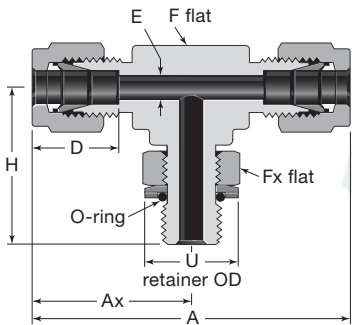

Tube ports are identical.

See page 9 for thread specifications.

Tube OD	ISO Thread Size in.	Basic Ordering Number	Dimensions							
			A	Ax	D	E ^①	F, in.	Fx, in.	H	U
Dimensions, in.										
1/4	1/8	-400-3TTR	2.12	1.06	0.60	0.16	1/2	9/16	1.04	0.60
	1/4	-400-3-4TTR	2.28	1.14	0.60	0.19	5/8	3/4	1.27	0.80
3/8	1/4	-600-3TTR	2.40	1.20	0.66	0.23	5/8	3/4	1.27	0.80
1/2	3/8	-810-3TTR	2.84	1.42	0.90	0.31	13/16	7/8	1.46	0.96
	1/2	-810-3-8TTR	3.00	1.50	0.90	0.41	15/16	1 1/16	1.71	1.16
5/8	1/2	-1010-3TTR	3.00	1.50	0.96	0.47	15/16	1 1/16	1.71	1.16
3/4	3/4	-1210-3TTR	3.14	1.57	0.96	0.62	1 1/16	1 3/8	1.92	1.43
	1/2	-1210-3-8TTR	3.14	1.57	0.96	0.47	1 1/16	1 1/16	1.78	1.16
1	1	-1610-3TTR	3.86	1.93	1.23	0.78	1 3/8	1 5/8	2.11	1.92
Dimensions, mm										
6	1/8	-6M0-3TTR	53.9	27.0	15.3	4.0	1/2	9/16	26.4	15.2
	1/4	-6M0-3-4TTR	58.0	29.0	15.3	4.8	5/8	3/4	32.2	20.3
8	1/8	-8M0-3TTR	57.7	30.0	16.2	4.0	9/16	9/16	28.4	15.2
	1/4	-8M0-3-4TTR	59.7	30.0	16.2	5.9	5/8	3/4	32.3	20.3
10	1/4	-10M0-3TTR	67.0	33.5	17.2	5.9	13/16	3/4	35.1	20.3
12	3/8	-12M0-3TTR	72.0	36.1	22.8	7.9	13/16	7/8	37.1	24.4
	1/2	-12M0-3-8TTR	76.1	38.1	22.8	9.5	5/16	1 1/16	43.4	29.5

① The E dimension is the minimum nominal opening. These fittings may have a larger opening at the pipe/straight thread end.

Positionable Run, SAE/MS Straight Thread (TST)

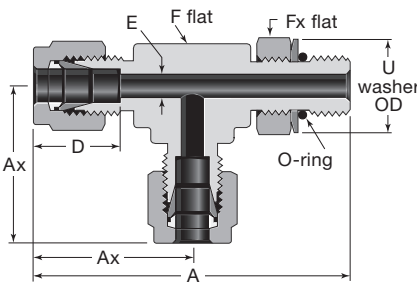

SAE/MS positionable fittings are available in carbon steel and stainless steel only.

Adapts to SAE J1926/1 and ISO 11926-1 straight thread boss.

Tube OD	SAE/MS Thread Size	Basic Ordering Number	Dimensions						
			A	Ax	D	E ^①	F	Fx	U
Dimensions, in.									
1/4	7/16-20	-400-3TST	2.24	1.12	0.60	0.19	1/2	9/16	0.65
3/8	9/16-18	-600-3TST	2.53	1.26	0.66	0.28	5/8	11/16	0.79
1/2	3/4-16	-810-3TST	2.97	1.48	0.90	0.41	13/16	7/8	1.01
3/4	1 1/16-12	-1210-3TST	3.55	1.63	0.96	0.62	1 1/16	1 1/4	1.44
1	1 5/16-12	-1610-3TST	4.10	1.99	1.23	0.88	1 3/8	1 1/2	1.73
1 1/4	1 5/8-12	-2000-3TST	4.96	2.67	1.62	1.09	1 11/16	1 7/8	2.16
1 1/2	1 7/8-12	-2400-3TST	5.45	3.07	1.97	1.34	2	2 1/8	2.45
2	2 1/2-12	-3200-3TST	7.04	4.22	2.66	1.81	2 3/4	2 3/4	3.16

① The E dimension is the minimum nominal opening. These fittings may have a larger opening at the pipe/straight thread end.

Refer to Installation Instructions, beginning on page 69.

Tees

Male

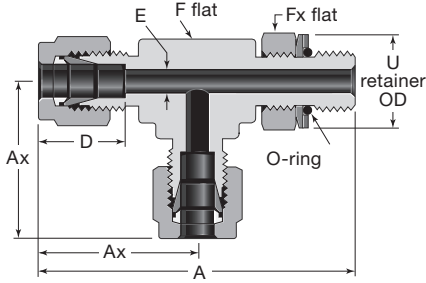

See page 9 for thread specifications.

Positionable Run, ISO/BSP Parallel Thread (TRT)

Tube OD	ISO Thread Size in.	Basic Ordering Number	Dimensions						
			A	Ax	D	E ^①	F, in.	Fx, in.	U
Dimensions, in.									
1/4	1/8 1/4	-400-3TRT -400-3-4TRT	2.10 2.41	1.06 1.14	0.60	0.16 0.19	1/2 5/8	9/16 3/4	0.60 0.80
3/8	1/4	-600-3TRT	2.47	1.20	0.66	0.23	5/8	3/4	0.80
1/2	3/8	-810-3TRT	2.88	1.42	0.90	0.31	13/16	7/8	0.96
	1/2	-810-3-8TRT	3.21	1.50		0.41	15/16	1 1/16	1.16
5/8	1/2	-1010-3TRT	3.21	1.50	0.96	0.47	15/16	1 1/16	1.16
3/4	3/4	-1210-3TRT	3.49	1.57	0.96	0.62	1 1/16	1 3/8	1.43
	1/2	-1210-3-8TRT	3.35			0.47	1 1/16	1 1/16	1.16
1	1	-1610-3TRT	4.04	1.93	1.23	0.78	1 3/8	1 5/8	1.82
Dimensions, mm									
6	1/8	-6M0-3TRT	53.4	27.0	15.3	4.0	1/2	9/16	15.2
	1/4	-6M0-3-4TRT	61.2	29.0		4.8	5/8	3/4	20.3
8	1/8	-8M0-3TRT	56.3	28.8	16.2	4.0	9/16	9/16	15.2
	1/4	-8M0-3-4TRT	62.1	29.9		6.4	5/8	3/4	20.3
10	1/4	-10M0-3TRT	68.6	33.5	17.2	5.9	13/16	3/4	20.3
12	3/8	-12M0-3TRT	73.1	36.0	22.8	7.9	13/16	7/8	24.4
	1/2	-12M0-3-8TRT	81.5	38.0		9.5	15/16	1 1/16	29.5

① The E dimension is the minimum nominal opening. These fittings may have a larger opening at the pipe/straight thread end.

Female

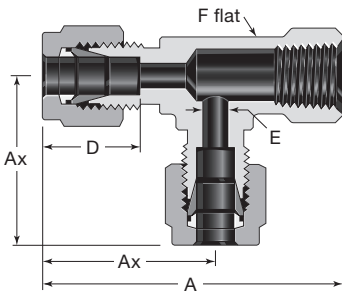

Tube ports are identical.

Run, NPT (TFT)

Tube OD	NPT Size in.	Basic Ordering Number	Dimensions				
			A	Ax	D	E	F, in.
Dimensions, in.							
1/8	1/8	-200-3TFT	1.72	0.97	0.50	0.09	1/2
1/4	1/8	-400-3TFT	1.81	1.06	0.60	0.19	1/2
	1/4	-400-3-4TFT	2.05	1.17			11/16
3/8	1/4	-600-3TFT	2.11	1.23	0.66	0.28	11/16
1/2	3/8	-810-3TFT	2.30	1.42	0.90	0.41	13/16
	1/2	-810-3-8TFT	2.69	1.57			1 1/16
3/4	3/4	-1210-3TFT	3.01	1.76	0.96	0.62	1 3/8
1	3/4	-1610-3-12TFT	3.18	1.93	1.23	0.88	1 3/8
	1	-1610-3TFT	3.61	2.11			1 11/16
Dimensions, mm							
6	1/8	-6M0-3TFT	46.0	27.0	15.3	4.8	1/2
	1/4	-6M0-3-4TFT	52.1	29.8			11/16
8	1/8	-8M0-3TFT	48.9	29.9	16.2	6.4	5/8
	1/4	-8M0-3-4TFT	53.0	30.6			11/16
10	1/4	-10M0-3TFT	55.9	33.5	17.2	7.9	13/16
12	1/4	-12M0-3-4TFT	58.4	36.0	22.8	9.5	13/16
	3/8	-12M0-3TFT	58.4	36.0		10.3	13/16
	1/2	-12M0-3-8TFT	68.3	39.8		9.5	1 1/16
16	1/2	-16M0-3TFT	68.2	39.8	24.4	12.7	1 1/16

Refer to Installation Instructions, beginning on page 69.

Tees

Female

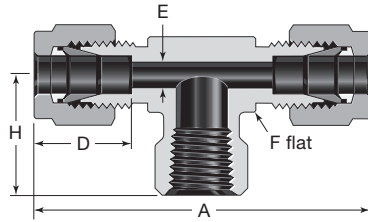

Branch, NPT (TTF)

Tube OD	NPT Size in.	Basic Ordering Number	Dimensions				
			A	D	E	F, in.	H
Dimensions, in.							
1/8	1/8	-200-3TTF	1.94	0.50	0.09	1/2	0.75
1/4	1/8	-400-3TTF	2.12	0.60	0.19	1/2	0.75
	1/4	-400-3-4TTF	2.34				0.88
3/8	1/4	-600-3TTF	2.46	0.66	0.28	11/16	0.88
	3/8	-600-3-6TTF	2.62				0.88
	1/2	-600-3-8TTF	2.84				1.12
1/2	1/4	-810-3-4TTF	2.84	0.90	0.41	13/16	0.88
	3/8	-810-3TTF	2.84				0.88
	1/2	-810-3-8TTF	3.06				1.12
5/8	1/2	-1010-3TTF	3.06	0.96	0.50	1	1.12
3/4	3/4	-1210-3TTF	3.52	0.96	0.62	1 3/8	1.25
1	3/4	-1610-3-12TTF	3.86	1.23	0.88	1 3/8	1.25
	1	-1610-3TTF	4.22				1.50
Dimensions, mm							
6	1/8	-6M0-3TTF	53.9	15.3	4.8	1/2	19.0
	1/4	-6M0-3-4TTF	59.5				22.4
8	1/8	-8M0-3TTF	59.7	16.2	6.4	5/8	19.0
	1/4	-8M0-3-4TTF	61.2				22.4
10	1/4	-10M0-3TTF	67.0	17.2	7.9	13/16	22.4
12	1/4	-12M0-3-4TTF	72.0	22.8	9.5	13/16	22.4
	3/8	-12M0-3TTF	72.0				22.4
	1/2	-12M0-3-8TTF	77.7				28.4
16	1/2	-16M0-3TTF	77.6	24.4	12.7	1	28.4

Cross

Union

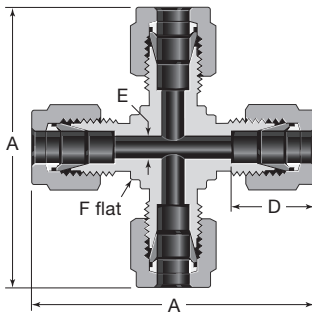

Tube OD	Basic Ordering Number	Dimensions			
		A	D	E	F, in.
Dimensions, in.					
1/8	-200-4	1.76	0.50	0.09	3/8
1/4	-400-4	2.12	0.60	0.19	1/2
5/16	-500-4	2.34	0.64	0.25	5/8
3/8	-600-4	2.40	0.66	0.28	5/8
1/2	-810-4	2.84	0.90	0.41	13/16
3/4	-1210-4	3.14	0.96	0.62	1 1/16
1	-1610-4	3.86	1.23	0.88	1 3/8
Dimensions, mm					
3	-3M0-4	44.7	12.9	2.4	3/8
6	-6M0-4	53.9	15.3	4.8	1/2
8	-8M0-4	59.7	16.2	6.4	5/8
10	-10M0-4	67.0	17.2	7.9	13/16
12	-12M0-4	72.0	22.8	9.5	13/16
16	-16M0-4	74.0	24.4	12.7	15/16
18	-18M0-4	76.6	24.4	15.1	1 1/16
20	-20M0-4	89.3	26.0	15.9	1 3/8
22	-22M0-4	89.4	26.0	18.3	5/8
25	-25M0-4	98.3	31.3	21.8	1 3/8

Refer to Installation Instructions, beginning on page 69.

Sanitary Flange Fittings

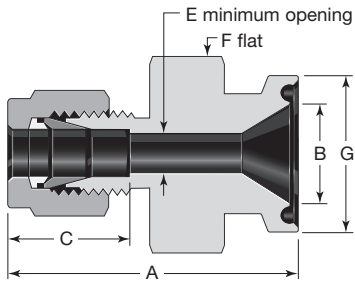

Kwik-Clamp Flange To Swagelok Tube Fitting

Tube OD in.	Flange Size in.	Ordering Number	Dimensions, in. (mm)					
			A	B	C	E	F	G
1/4	1/2	SS-400-SC-8	1.57 (39.9)	0.37 (9.4)	0.60 (15.2)	0.19 (4.8)	1	0.98 (24.9)
	3/4	SS-400-SC-12	1.57 (39.9)	0.62 (15.7)	0.60 (15.2)	0.19 (4.8)	1	0.98 (24.9)
	1	SS-400-SC-16	1.57 (39.9)	0.87 (22.1)	0.60 (15.2)	0.19 (4.8)	13/16	1.98 (50.3)
	1 1/2	SS-400-SC-24	1.75 (44.4)	1.37 (34.8)	0.60 (15.2)	0.19 (4.8)	1 1/4	1.98 (50.3)
3/8	1/2	SS-600-SC-8	1.63 (41.4)	0.37 (9.4)	0.66 (16.8)	0.28 (7.1)	1	0.98 (24.9)
	3/4	SS-600-SC-12	1.63 (41.4)	0.62 (15.7)	0.66 (16.8)	0.28 (7.1)	1	0.98 (24.9)
	1	SS-600-SC-16	1.63 (41.4)	0.87 (22.1)	0.66 (16.8)	0.28 (7.1)	13/16	1.98 (50.3)
	1 1/2	SS-600-SC-24	1.72 (43.7)	1.37 (34.8)	0.66 (16.8)	0.28 (7.1)	1 1/4	1.98 (50.3)
1/2	1/2	SS-810-SC-8	1.74 (44.2)	0.37 (9.4)	0.90 (22.9)	0.37 (9.4)	1	0.98 (24.9)
	3/4	SS-810-SC-12	1.74 (44.2)	0.62 (15.7)	0.90 (22.9)	0.40 (10.2)	1	0.98 (24.9)
	1	SS-810-SC-16	1.74 (44.2)	0.87 (22.1)	0.90 (22.9)	0.40 (10.2)	13/16	1.98 (50.3)
	1 1/2	SS-810-SC-24	1.80 (45.7)	1.37 (34.8)	0.90 (22.9)	0.40 (10.2)	1 1/4	1.98 (50.3)
1	1	SS-1610-SC-16	1.92 (48.8)	0.87 (22.1)	1.24 (31.5)	0.87 (22.1)	1 1/4	1.98 (50.3)
	2	SS-1610-SC-32	2.50 (63.5)	1.87 (47.5)	1.24 (31.5)	0.87 (22.1)	2 3/4	2.52 (64.0)

Refer to Installation Instructions, beginning on page 69.

Orifice Plate Fittings

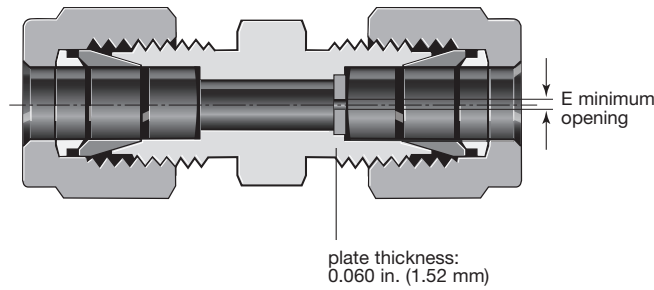

- Restrict flow in process and analytical systems
- Constructed from 316 SS as standard. When ordering an end connection in another material, the orifice plate is available in the matching material.

The minimum orifice size (E dimension) that an orifice plate can be machine-drilled to is 0.010 in. (0.3 mm). Orifice sizes from 0.001 in. (0.03 mm) to 0.009 in. (0.23 mm) can be laser-drilled.

The maximum orifice size (E) that can be selected is dependent on the tube fitting size. Please see the maximum E dimension that can be provided for each fitting size.

Typical Ordering Number

S S - 810-6PD-.256

Base
Ordering Number

E-dimension will be between .010 in. (0.3 mm) and maximum E dimension for size of tube fitting.

Typical Laser-Drilled Ordering Number

S S - 810-6 PD LD - .001

Base
Ordering Number

Orifice Size

Value between 0.001 in. (0.03 mm) and 0.009 in. (0.23 mm).

Laser-drilled plate

Include when ordering orifice sizes between 0.001 in. (0.03 mm) and 0.009 in. (0.23 mm).

Plate Style

- PD** = Orifice plate assembled in tube port (if more than one, then larger end; if tee, then on run); orifice plate is 316 SS
- PK** = Orifice plate assembled in tube port (if more than one, then larger end; if tee, then on run); orifice plate same material as body
- PE** = Orifice plates assembled in both tube ports on run
- PF** = Orifice plates assembled in one tube port on run and tube port on branch
- PG** = Orifice plate assembled in one tube port on branch
- PH** = Orifice plates assembled in both tube ports on run and one in branch tube port
- PJ** = Orifice plate assembled in one end of a pipe fitting
- PL** = Orifice plate assembled in smaller tube port

For special orifice fitting requirements - contact your authorized Swagelok representative.

Maximum E Dimension

Fitting Tube OD	E, in.
Dimensions	
1/8 in., 3 mm, 4 mm	0.070
3/16 in.	0.117
1/4 in., 6 mm	0.164
5/16 in., 8 mm	0.211
3/8 in., 10 mm	0.258
12 mm	0.328
1/2 in.	0.352
14 mm	0.384
15 mm	0.415
5/8 in., 16 mm	0.446
18 mm	0.508
3/4 in., 20 mm	0.539
7/8 in., 22 mm	0.633
1 in., 25 mm	0.727
1 1/4 in.	0.891
1 1/2 in.	1.090
2 in.	1.394

Refer to Installation Instructions, beginning on page 69.

Tube Adapters

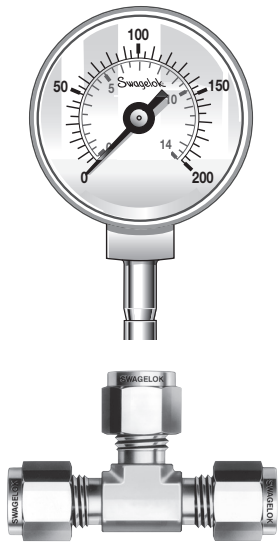

Solve Alignment Problems and Reduce Inventories

Swagelok tube adapters can help eliminate difficult alignment problems and reduce inventories. Swagelok tube adapters can be used with any Swagelok tube fittings in this catalog. So, stocking union elbows and union tees in various sizes and materials—along with commonly used Swagelok adapters—eliminates the need for stocking special elbows and tees.

Typical Alignment Problem

When installing pipe elbows or tees, it is often difficult to align the fitting with the desired run.

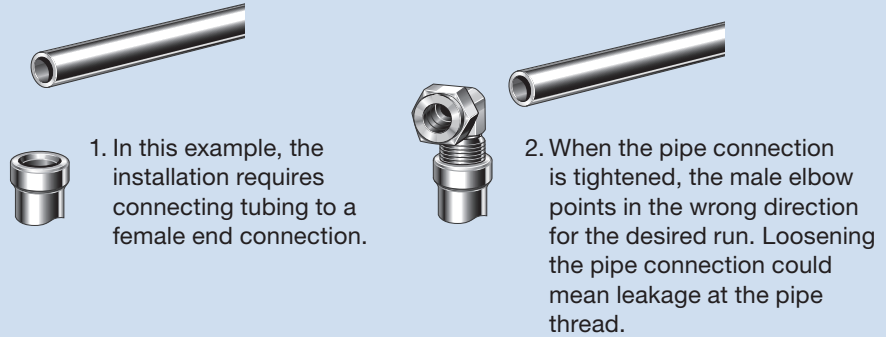

Swagelok Solution

By using a Swagelok tube adapter in conjunction with a union elbow or tee, these difficulties can be avoided.

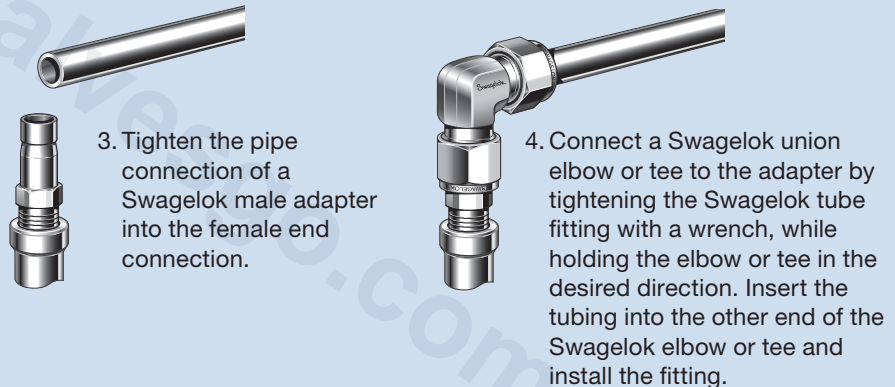

⚠ Swagelok tube adapters are to be used ONLY in Swagelok tube fittings. Use in fittings made by other manufacturers may result in leakage or slippage.

Refer to Installation Instructions, beginning on page 69.

Tube Adapters

Male

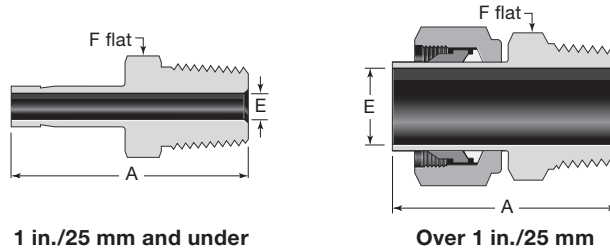

NPT

Tube OD	NPT Size in.	Basic Ordering Number	Dimensions		
			A	E ^①	F
Dimensions, in.					
1/8	1/8	-2-TA-1-2	1.16	0.08	7/16
	1/4	-2-TA-1-4	1.37		9/16
3/16	1/8	-3-TA-1-2	1.19	0.12	7/16
	1/4	-3-TA-1-4	1.40		9/16
1/4	1/8	-4-TA-1-2	1.25	0.17	7/16
	1/4	-4-TA-1-4	1.46		9/16
	3/8	-4-TA-1-6	1.49		11/16
	1/2	-4-TA-1-8	1.71		7/8
5/16	1/8	-5-TA-1-2	1.29	0.19	7/16
	1/4	-5-TA-1-4	1.50	0.22	9/16
3/8	1/8	-6-TA-1-2	1.32	0.19	7/16
	1/4	-6-TA-1-4	1.53	0.27	9/16
	3/8	-6-TA-1-6	1.56	0.27	11/16
	1/2	-6-TA-1-8	1.78	0.27	7/8
1/2	1/4	-8-TA-1-4	1.75	0.28	9/16
	3/8	-8-TA-1-6	1.78	0.37	11/16
	1/2	-8-TA-1-8	2.00	0.37	7/8
5/8	1/2	-10-TA-1-8	2.06	0.47	7/8
	3/4	1/2	-12-TA-1-8	2.06	0.47
3/4		3/4	-12-TA-1-12	2.06	0.58
	1	3/4	-16-TA-1-12	2.31	0.62
1		-16-TA-1-16	2.60	0.80	1 3/8
1 1/4	1 1/4	-20-TA-1-20 ^②	3.16	1.02	1 3/4
1 1/2	1 1/2	-24-TA-1-24 ^②	3.72	1.25	2 1/8
2	2	-32-TA-1-32 ^②	4.70	1.72	2 3/4
Dimensions, mm					
6	1/8	-6-MTA-1-2	32.8	4.1	12
	1/4	-6-MTA-1-4	38.1		14
8	1/4	-8-MTA-1-4	39.1	5.6	14
	3/8	-8-MTA-1-6	39.9		19
10	1/4	-10-MTA-1-4	39.9	7.1	14
	3/8	-10-MTA-1-6	40.6		18
	1/2	-10-MTA-1-8	46.2		22
12	1/4	-12-MTA-1-4	46.5	7.1	16
	1/2	-12-MTA-1-8	52.1	8.8	22
28	1	-28-MTA-1-16 ^②	74.7	22.2	35
	1 1/4	-28-MTA-1-20 ^②	76.2	22.5	46
	1	B-28-MTA-1-16	68.6	22.2	1 3/8 in.
1 1/4	B-28-MTA-1-20	70.1	22.6		
30	1	-30-MTA-1-16 ^②	79.2	22.2	41
30	1 1/4	-30-MTA-1-20 ^②	80.0	24.3	46
32	1 1/4	-32-MTA-1-20 ^②	81.0	26.5	46
38	1 1/2	-38-MTA-1-24 ^②	92.2	31.6	55

① The E dimension is the minimum nominal opening. These fittings may have a larger opening at the pipe/straight thread end.

② Furnished with nut and preswaged ferrules.

ISO/BSP Tapered Thread (RT)

Tube OD	ISO Thread Size in.	Basic Ordering Number	Dimensions		
			A	E ^①	F
Dimensions, in.					
1/8	1/8	-2-TA-1-2RT	1.16	0.08	7/16
	1/4	-2-TA-1-4RT	1.37		9/16
1/4	1/8	-4-TA-1-2RT	1.25	0.17	7/16
	1/4	-4-TA-1-4RT	1.46		9/16
3/8	1/4	-6-TA-1-4RT	1.53	0.27	9/16
	3/8	-6-TA-1-6RT	1.56		11/16
	1/2	-6-TA-1-8RT	1.78		7/8
1/2	1/4	-8-TA-1-4RT	1.75	0.28	9/16
	3/8	-8-TA-1-6RT	1.78	0.37	11/16
	1/2	-8-TA-1-8RT	2.00	0.37	7/8
3/4	3/4	-12-TA-1-12RT	2.06	0.58	1 1/16
1	1	-16-TA-1-16RT	2.60	0.80	1 3/8
Dimensions, mm					
6	1/8	-6-MTA-1-2RT	32.8	4.1	12
	1/4	-6-MTA-1-4RT	38.1		14
8	1/4	-8-MTA-1-4RT	39.1	5.6	14
10	1/4	-10-MTA-1-4RT	39.9	7.1	14
	3/8	-10-MTA-1-6RT	40.6		18
12	1/4	-12-MTA-1-4RT	46.5	7.1	16
	3/8	-12-MTA-1-6RT	46.2	8.8	18
	1/2	-12-MTA-1-8RT	51.8	8.8	22
28	1	-28-MTA-1-16RT ^②	74.7	22.2	35
	1 1/4	-28-MTA-1-20RT ^②	76.2	22.5	46
	1	B-28-MTA-1-16RT	68.6	22.2	1 3/8 in.
1 1/4	B-28-MTA-1-20RT	70.1	22.6		
30	1 1/4	-30-MTA-1-20RT ^②	80.0	24.3	46
32	1 1/4	-32-MTA-1-20RT ^②	81.0	26.5	46
38	1 1/2	-38-MTA-1-24RT ^②	92.2	31.6	55

① The E dimension is the minimum nominal opening. These fittings may have a larger opening at the pipe/straight thread end.

② Furnished with nut and preswaged ferrules.

Refer to Installation Instructions, beginning on page 69.

Tube Adapters

Male

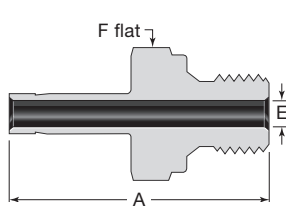

1 in./25 mm and under

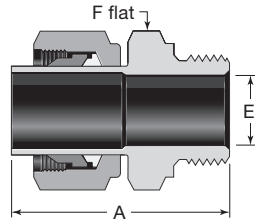

Over 1 in./25 mm

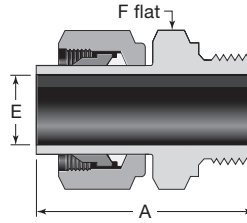

ISO/BSP parallel gaskets are available. See page 60.

ISO/BSP parallel gaskets are available. See page 60.

ISO/BSP Parallel Thread (RS)

Tube OD	ISO Thread Size in.	Basic Ordering Number	Dimensions		
			A	E ^①	F
Dimensions, in.					
1/8	1/8	-2-TA-1-2RS	1.25	0.08	9/16
	1/4	-2-TA-1-4RS	1.43		3/4
1/4	1/8	-4-TA-1-2RS	1.35	0.16	9/16
	1/4	-4-TA-1-4RS	1.53	0.17	3/4
3/8	1/4	-6-TA-1-4RS	1.59	0.23	3/4
	3/8	-6-TA-1-6RS	1.62	0.27	7/8
1/2	1/4	-8-TA-1-4RS	1.85	0.23	3/4
	3/8	-8-TA-1-6RS	1.88	0.31	7/8
	1/2	-8-TA-1-8RS	1.96	0.37	1 1/16
3/4	3/4	-12-TA-1-12RS	2.20	0.58	1 5/16
1	1	-16-TA-1-16RS	2.59	0.80	1 5/8
Dimensions, mm					
6	1/8	-6-MTA-1-2RS	34.3	4.0	14
	1/4	-6-MTA-1-4RS	38.9	4.1	19
8	1/4	-8-MTA-1-4RS	39.6	5.6	19
10	1/4	-10-MTA-1-4RS	40.4	5.9	19
	3/8	-10-MTA-1-6RS	41.1	7.1	22
	1/2	-10-MTA-1-8RS	43.2	7.1	27
12	1/4	-12-MTA-1-4RS	47.0	5.9	19
	3/8	-12-MTA-1-6RS	47.8	7.9	22
	1/2	-12-MTA-1-8RS	49.8	8.8	27
18	1/2	-18-MTA-1-8RS	51.3	11.9	27
	3/4	-18-MTA-1-12RS	55.9	13.9	35
28	1	-28-MTA-1-16RS ^②	71.9	19.8	41
	1 1/4	-28-MTA-1-20RS ^②	75.4	22.5	50
	1 1 1/4	B-28-MTA-1-16RS B-28-MTA-1-20RS	65.8 69.3	19.8 22.6	1 5/8 in. 50
30	1 1/4	-30-MTA-1-20RS ^②	79.8	24.3	50
32	1 1/4	-32-MTA-1-20RS ^②	80.8	26.5	50
38	1 1/2	-38-MTA-1-24RS ^②	91.9	31.6	55

① The E dimension is the minimum nominal opening. These fittings may have a larger opening at the pipe/straight thread end.

② Furnished with nut and preswaged ferrules.

ISO/BSP Parallel Thread (RP)

Tube OD	ISO Thread Size in.	Basic Ordering Number	Dimensions		
			A	E ^①	F
Dimensions, mm					
28	1	-28-MTA-1-16RP ^②	72.7	19.8	41
	1 1/4	-28-MTA-1-20RP ^②	77.3	22.5	50
	1 1 1/4	B-28-MTA-1-16RP B-28-MTA-1-20RP	65.8 71.1	19.8 22.6	1 5/8 in. 50
30	1 1/4	-30-MTA-1-20RP ^②	81.1	24.3	50
32	1 1/4	-32-MTA-1-20RP ^②	82.1	26.5	50
38	1 1/2	-38-MTA-1-24RP ^②	94.5	31.8	55

① The E dimension is the minimum nominal opening. These fittings may have a larger opening at the pipe/straight thread end.

② Furnished with nut and preswaged ferrules.

Refer to Installation Instructions, beginning on page 69.

Tube Adapters

Male

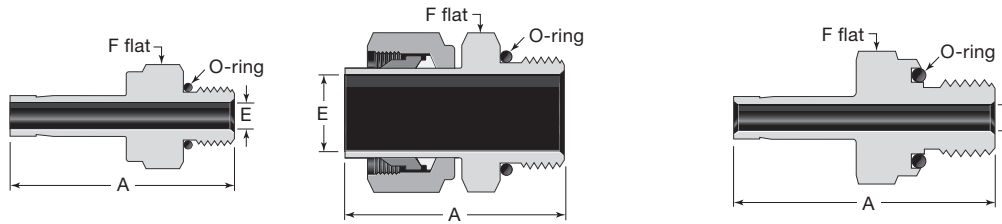

1 in./25 mm and under

Over 1 in./25 mm

See page 22 for mounting dimensions.

Adapts to SAE J1926/1 and ISO 11926-1 straight thread boss.

SAE/MS Straight Thread (ST)

Tube OD	SAE/MS Thread Size	Basic Ordering Number	Dimensions		
			A	E ^①	F
Dimensions, in.					
1/8	5/16-24	-2-TA-1-2ST	1.20	0.08	7/16
1/4	7/16-20	-4-TA-1-4ST	1.39	0.17	9/16
3/8	7/16-20	-6-TA-1-4ST	1.46	0.20	9/16
	9/16-18	-6-TA-1-6ST	1.52	0.27	11/16
1/2	3/4-16	-6-TA-1-8ST	1.60	0.27	7/8
	9/16-18	-8-TA-1-6ST	1.74	0.28	11/16
5/8	3/4-16	-8-TA-1-8ST	1.82	0.37	7/8
	7/8-14	-10-TA-1-10ST	1.94	0.47	1
3/4	1 1/16-12	-12-TA-1-12ST	2.10	0.58	1 1/4
1	1 5/16-12	-16-TA-1-16ST	2.41	0.80	1 1/2
1 1/4	1 5/8-12	-20-TA-1-20ST ^②	2.81	1.02	1 7/8
1 1/2	1 7/8-12	-24-TA-1-24ST ^②	3.28	1.25	2 1/8
2	2 1/2-12	-32-TA-1-32ST ^②	4.23	1.72	2 3/4

① The E dimension is the minimum nominal opening. These fittings may have a larger opening at the pipe/straight thread end.

② Furnished with nut and preswaged ferrules.

O-Seal (SAE/MS Straight Thread)

Tube OD	SAE/MS Thread Size	Basic Ordering Number	Dimensions		
			A	E	F
Dimensions, in.					
1/8	5/16-24	-2-TA-1-OR	1.28	0.08	9/16
3/16	3/8-24	-3-TA-1-OR	1.38	0.12	5/8
1/4	7/16-20	-4-TA-1-OR	1.54	0.17	3/4
5/16	1/2-20	-5-TA-1-OR	1.64	0.22	7/8
3/8	9/16-18	-6-TA-1-OR	1.70	0.27	15/16
1/2	3/4-16	-8-TA-1-OR	1.95	0.37	1 1/8

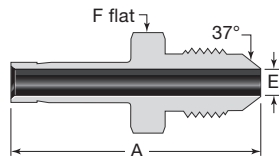

AN Thread

Tube OD	AN Tube Flare Size	Thread Size	Basic Ordering Number	Dimensions		
				A	E ^①	F
Dimensions, in.						
1/4	1/4	7/16-20UNJF-3	-4-TA-1-4AN	1.46	0.17	1/2
3/8	1/4	7/16-20UNJF-3	-6-TA-1-4AN	1.53	0.17	1/2
	3/8	9/16-18UNJF-3	-6-TA-1-6AN	1.56	0.27	5/8
1/2	1/2	3/4-16UNJF-3	-8-TA-1-8AN	1.91	0.37	13/16
3/4	3/4	1 1/16-12UNJ-3	-12-TA-1-12AN	2.21	0.58	1 1/8
1	1	1 5/16-12UNJ-3	-16-TA-1-16AN	2.58	0.80	1 3/8

① The E dimension is the minimum nominal opening. These fittings may have a larger opening at the pipe/straight thread end.

Refer to Installation Instructions, beginning on page 69.

Tube Adapters

Male

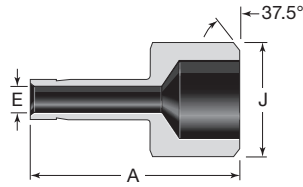

Pipe Weld

Tube OD	Pipe Weld Size	Basic Ordering Number	Dimensions		
			A	E	J
Dimensions, in.					
1/4	1/4	-4-TA-1-4W	1.14	0.17	0.540
3/8	1/2	-6-TA-1-8W	1.46	0.27	0.840
1/2	1/2	-8-TA-1-8W	1.66	0.37	0.840
	3/4	-8-TA-1-12W	1.68		1.050
3/4	3/4	-12-TA-1-12W	1.87	0.58	1.050

Wall thickness at weld end is based on schedule 80 pipe.

Female

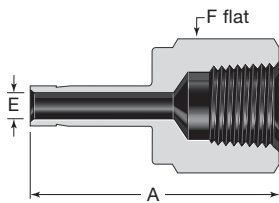

1 in./25 mm and under

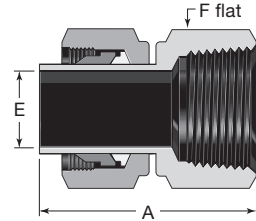

Over 1 in./25 mm

NPT

Tube OD	NPT Size in.	Basic Ordering Number	Dimensions		
			A	E	F
Dimensions, in.					
1/8	1/8	-2-TA-7-2	1.24	0.08	9/16
	1/4	-2-TA-7-4	1.39		3/4
3/16	1/4	-3-TA-7-4	1.41	0.12	3/4
1/4	1/8	-4-TA-7-2	1.30	0.17	9/16
	1/4	-4-TA-7-4	1.46		3/4
	3/8	-4-TA-7-6	1.55		7/8
	1/2	-4-TA-7-8	1.79		1 1/16
5/16	1/4	-5-TA-7-4	1.48	0.22	3/4
3/8	1/8	-6-TA-7-2	1.35	0.27	9/16
	1/4	-6-TA-7-4	1.50		3/4
	3/8	-6-TA-7-6	1.59		7/8
	1/2	-6-TA-7-8	1.84		1 1/16
1/2	1/4	-8-TA-7-4	1.71	0.37	3/4
	3/8	-8-TA-7-6	1.79		7/8
	1/2	-8-TA-7-8	2.05		1 1/16
5/8	1/2	-10-TA-7-8	2.09	0.47	1 1/16
3/4	1/2	-12-TA-7-8	2.08	0.58	1 1/16
	3/4	-12-TA-7-12	2.16		1 5/16
	1	-12-TA-7-16	2.30		1 5/8
1	3/4	-16-TA-7-12	2.39	0.80	1 5/16
	1	-16-TA-7-16	2.53		1 5/8
1 1/4	1 1/4	-20-TA-7-20 ^①	3.06	1.02	2 1/8
1 1/2	1 1/2	-24-TA-7-24 ^①	3.50	1.25	2 3/8
	2	-32-TA-7-32 ^①	4.23		2 7/8
Dimensions, mm					
6	1/8	-6-MTA-7-2	32.5	4.1	14
	1/4	-6-MTA-7-4	37.1		19
8	1/4	-8-MTA-7-4	37.6	5.6	19
10	1/4	-10-MTA-7-4	38.1	7.1	19
	3/8	-10-MTA-7-6	40.1		22
	1/2	-10-MTA-7-8	46.7		27
12	1/4	-12-MTA-7-4	43.7	8.8	19
	1/2	-12-MTA-7-8	52.3		27

① Furnished with nut and preswaged ferrules.

ISO/BSP Tapered Thread (RT)

Tube OD	ISO Thread Size in.	Basic Ordering Number	Dimensions		
			A	E	F
Dimensions, in.					
1/4	1/8	-4-TA-7-2RT	1.30	0.17	9/16
	1/4	-4-TA-7-4RT	1.45		3/4
3/8	1/4	-6-TA-7-4RT	1.50	0.27	3/4
	3/8	-6-TA-7-6RT	1.59		7/8
1/2	1/4	-8-TA-7-4RT	1.71	0.37	3/4
	3/8	-8-TA-7-6RT	1.80		7/8
	1/2	-8-TA-7-8RT	2.05		1 1/16
Dimensions, mm					
6	1/8	-6-MTA-7-2RT	33.0	4.1	14
8	1/4	-8-MTA-7-4RT	37.6	5.6	19
10	1/4	-10-MTA-7-4RT	38.1	7.1	19

Refer to Installation Instructions, beginning on page 69.

Tube Adapters

Female

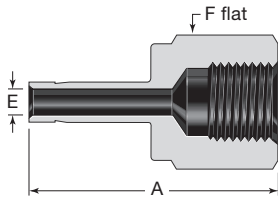

ISO/BSP parallel gaskets and O-rings are available. See page 60.

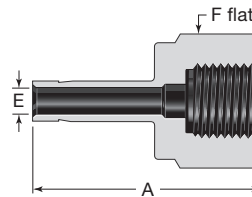

ISO/BSP parallel gaskets and O-rings are available. See page 60.

ISO/BSP Parallel Thread (RP)

Tube OD	ISO Thread Size in.	Basic Ordering Number	Dimensions		
			A	E	F
Dimensions, in.					
1/8	1/8	-2-TA-7-2RP	1.17	0.08	9/16
1/4	1/8	-4-TA-7-2RP	1.25	0.17	9/16
	1/4	-4-TA-7-4RP	1.50		3/4
3/8	1/4	-6-TA-7-4RP	1.55	0.27	3/4
	3/8	-6-TA-7-6RP	1.57		15/16
1/2	3/8	-8-TA-7-6RP	1.78	0.38	15/16
	1/2	-8-TA-7-8RP	2.02		1 1/16
Dimensions, mm					
6	1/8	-6-MTA-7-2RP	32.0	4.1	14
	1/4	-6-MTA-7-4RP	37.8		19
12	1/2	-12-MTA-7-8RP	49.8	8.8	27

ISO/BSP Parallel Thread (RG, Gauge)

Tube OD	ISO Thread Size in.	Basic Ordering Number	Dimensions		
			A	E	F
Dimensions, in.					
1/4	1/4	-4-TA-7-4RG	1.39	0.17	3/4
3/8	3/8	-6-TA-7-6RG	1.55	0.26	15/16
1/2	1/2	-8-TA-7-8RG	1.80	0.28	1 1/16
Dimensions, mm					
6	1/4	-6-MTA-7-4RG	35.3	4.1	19
	3/8	-6-MTA-7-6RG	38.4		24
	1/2	-6-MTA-7-8RG	42.9		27
8	1/4	-8-MTA-7-4RG	33.0	5.5	19
	3/8	-8-MTA-7-6RG	38.9		24
	1/2	-8-MTA-7-8RG	43.7		27
10	1/4	-10-MTA-7-4RG	34.5	5.5	19
	3/8	-10-MTA-7-6RG	36.1		24
	1/2	-10-MTA-7-8RG	41.1		27
12	1/4	-12-MTA-7-4RG	40.1	5.5	19
	3/8	-12-MTA-7-6RG	44.7		24
	1/2	-12-MTA-7-8RG	48.8		27
16	1/2	-16-MTA-7-8RG	49.0	7.0	27
18	1/2	-18-MTA-7-8RG	49.3	7.0	27

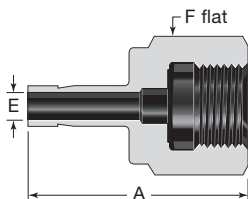

ISO/BSP parallel thread (RJ) fittings are available in stainless steel only. ISO/BSP parallel gaskets and O-rings are available. See page 60.

ISO/BSP Parallel Thread (RJ)

Tube OD	ISO Thread Size in.	Ordering Number	Dimensions		
			A	E	F
Dimensions, in.					
1/4	1/4	SS-4-TA-7-4RJ	1.39	0.17	3/4
3/8	3/8	SS-6-TA-7-6RJ	1.55	0.26	15/16
1/2	1/2	SS-8-TA-7-8RJ	1.94	0.28	1 1/16
Dimensions, mm					
6	1/4	SS-6-MTA-7-4RJ	35.3	4.1	19
	3/8	SS-6-MTA-7-6RJ	38.6		24
	1/2	SS-6-MTA-7-8RJ	42.9		27
8	1/4	SS-8-MTA-7-4RJ	33.0	5.5	19
	3/8	SS-8-MTA-7-6RJ	39.4		24
	1/2	SS-8-MTA-7-8RJ	43.7		27
10	1/4	SS-10-MTA-7-4RJ	34.5	5.5	19
	3/8	SS-10-MTA-7-6RJ	36.1		24
	1/2	SS-10-MTA-7-8RJ	41.1		27
12	1/4	SS-12-MTA-7-4RJ	40.1	5.5	19
	3/8	SS-12-MTA-7-6RJ	44.7		24
	1/2	SS-12-MTA-7-8RJ	48.8		27

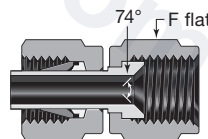

AN Thread

Tube OD	AN Tube Flare Size	Basic Ordering Number	F
			Dimensions, in.
1/8	1/8	-200-A-2ANF	3/8
	1/4	-200-A-4ANF	9/16
1/4	1/4	-400-A-4ANF	9/16
3/8	3/8	-600-A-6ANF	11/16
1/2	1/2	-810-A-8ANF	7/8
3/4	3/4	-1210-A-12ANF	1 1/4

Refer to Installation Instructions, beginning on page 69.

Additional Ordering Information

Swagelok tube fitting ordering numbers follow the sequence shown below.

A - **B C D** - **E** - **F G**
SS - **2 0 0** - **1** - **2 RT**

A Material

A = Aluminum
B = Brass
HC = Alloy C-276
INC = Alloy 600
M = Alloy 400
S = Carbon steel
SS = 316 stainless steel
6ELT = High-temperature 316 stainless steel
T = PTFE
TI = Titanium
6MO = 6-Moly
625 = Alloy 625
825 = Alloy 825
2507 = Alloy 2507

B Size (Tube OD)

Fractional, in.	Metric, mm
1 = 1/16	2 = 2
2 = 1/8	3 = 3
3 = 3/16	4 = 4
4 = 1/4	6 = 6
5 = 5/16	8 = 8
6 = 3/8	10 = 10
8 = 1/2	12 = 12
10 = 5/8	14 = 14
12 = 3/4	15 = 15
14 = 7/8	16 = 16
16 = 1	18 = 18
18 = 1 1/8	20 = 20
20 = 1 1/4	22 = 22
24 = 1 1/2	25 = 25
32 = 2	28 = 28
	32 = 32
	38 = 38
	50 = 50

C Series

0 = Fractional 1/16 to 3/8 in. and 1 1/4 to 2 in.
1 = Fractional 1/2 to 1 1/8 in.
3 = HC 3/4 in., 1 in., and 18 mm with advanced geometry ferrules
M = Millimeter tube size

To order a female Swagelok tube fitting, add **F**.
 Example: SS-1F0-1-1.

D Component

0 = Fitting
1 = Body

E Fitting Type

1 = Male connector
2 = 90° male elbow
3 = Tee, union
4 = Cross, union
5 = 45° male elbow
6 = Union
7 = Female connector
8 = Female elbow
9 = Elbow, union
11 = Bulkhead male connector
61 = Bulkhead union
71 = Bulkhead female connector
A = Adapter
C = Cap
P = Plug
PC = Port connector
R = Reducer
R1 = Bulkhead reducer
2R = Reducing elbow
TFT = Tee, female run
TMT = Tee, male run
TRT = Tee, ISO/BSP parallel male positionable run
TST = Tee, straight thread with O-ring male positionable run
TTF = Tee, female branch
TTM = Tee, male branch
TTR = Tee, ISO/BSP parallel male positionable branch
TTS = Tee, straight thread with O-ring male positionable branch

F Second End Connection Size

Add a size designator from the list at left for the second end connection or if the fitting is a reducing union.

G Second End Connection Type

Add a second end connection type designator as needed.

AN = 37° male AN flare
ANF = 37° female AN flare
BT = Bored-through fitting
F = Female thread
KN = Knurled nut, nylon ferrules
KT = Knurled nut, PTFE ferrules
M = Metric tube end
OR = O-seal connection
PR = ISO/BSP positionable parallel pipe thread
RG = ISO/BSP parallel pipe thread (gauge)
RJ = ISO/BSP parallel pipe thread (Japanese gauge)
RP = ISO/BSP parallel pipe thread
RS = ISO/BSP parallel pipe thread
RT = ISO/BSP tapered pipe thread
ST = Straight thread with O-ring (for SAE/MS)
W = Male pipe weld/tube socket weld

Tees and Crosses

Ordering numbers for tees and crosses indicate first the size of the run (**1** to **2**) and then the size of the branch (**3** for tees and **3** to **4** for crosses).

Example: SS-6M0-3-4TTF for a 316 SS female tee for 6 mm tube with 1/4 in. female NPT branch

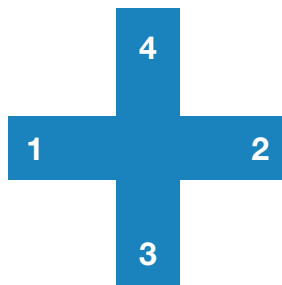

Additional Sizes and Materials

Contact your authorized Swagelok representative for information about additional sizes and special alloys.

Additional Ordering Information

Swagelok tube adapter ordering numbers follow the sequence shown below.

A - **B** - **C** - **D** - **E** **F**
SS - **2** - **TA** - **1** - **4** **RT**

A Material

A = Aluminum
B = Brass
HC = Alloy C-276
INC = Alloy 600
M = Alloy 400
S = Carbon steel
SS = 316 stainless steel
6ELT = High-temperature
 316 stainless steel
T = PTFE
TI = Titanium
6MO = 6-Moly
625 = Alloy 625
825 = Alloy 825
2507 = Alloy 2507

B Size (Tube OD)

Fractional, in.	Metric, mm
1 = 1/16	2 = 2
2 = 1/8	3 = 3
3 = 3/16	4 = 4
4 = 1/4	6 = 6
5 = 5/16	8 = 8
6 = 3/8	10 = 10
8 = 1/2	12 = 12
10 = 5/8	14 = 14
12 = 3/4	15 = 15
14 = 7/8	16 = 16
16 = 1	18 = 18
18 = 1 1/8	20 = 20
20 = 1 1/4	22 = 22
24 = 1 1/2	25 = 25
32 = 2	28 = 28
	32 = 32
	38 = 38
	50 = 50

C Component

TA = Fractional tube adapter
MTA = Metric tube adapter

D Adapter Type

1 = Male adapter
7 = Female adapter

E Second End Connection Size

Add a size designator from the list at left for the second end connection.

F Second End Connection Type

Add a second end connection type designator as needed.

AN = 37° male AN flare
ANF = 37° female AN flare
RG = ISO/BSP parallel pipe thread
 (gauge)
RJ = ISO/BSP parallel pipe thread
 (Japanese gauge)
RP = ISO/BSP parallel pipe thread
RS = ISO/BSP parallel pipe thread
RT = ISO/BSP tapered pipe thread
ST = Straight thread with O-ring
 (for SAE/MS)
W = Male pipe weld/tube socket
 weld

Replacement Parts

To order, add a material designator from the **How to Order** table on page 14.

Nuts

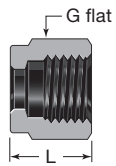

Female

Tube OD	Basic Ordering Number	Dimensions	
		G	L
Dimensions, in.			
1/16	-102-1	5/16	0.31
1/8	-202-1	7/16	0.47
3/16	-302-1	1/2	0.47
1/4	-402-1	9/16	0.50
5/16	-502-1	5/8	0.53
3/8	-602-1	11/16	0.56
1/2	-812-1	7/8	0.69
5/8	-1012-1	1	0.69
3/4	-1212-1	1 1/8	0.69
7/8	-1412-1	1 1/4	0.69
1	-1612-1	1 1/2	0.81
1 1/4	-2002-1	1 7/8	1.25
1 1/2	-2402-1	2 1/4	1.50
2	-3202-1	3	2.06

Tube OD	Basic Ordering Number	Dimensions	
		G	L
Dimensions, mm			
2	-2M2-1	12	11.9
3	-3M2-1	12	11.9
4	-4M2-1	12	11.9
6	-6M2-1	14	12.7
8	-8M2-1	16	13.5
10	-10M2-1	19	15.1
12	-12M2-1	22	17.4
14	-14M2-1	25	17.4
15	-15M2-1	25	17.4
16	-16M2-1	25	17.4
18	-18M2-1	30	17.4
20	-20M2-1	32	17.4
22	-22M2-1	32	17.4
25	-25M2-1	38	20.6
28	-28M2-1	46	30.6
	B-28M2-1	45	20.6
30	-30M2-1	50	32.7
32	-32M2-1	50	34.4
38	-38M2-1	60	40.6
50	-50M2-1	3 in.	52.3

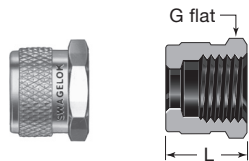

Knurled Female

The Swagelok knurled nut tube fitting provides a leak-tight seal without the use of inserts on most wall thicknesses of polyethylene tubing. Inserts may be required for larger sizes.

To set the ferrules on the tubing, initial connections must be made with a wrench, tightening the nut one and one-quarter turns from finger-tight (three-quarter turn for 1/16, 1/8 and 3/16 in.; 2, 3, and 4 mm fittings). Leak-tight connections may be reassembled with finger-tight assembly.

To order a knurled nut, add **K** to the female nut basic ordering number.

Example: B-402-1**K**

To order a knurled nut on an assembled fitting with nylon ferrules, add **KN** to the fitting ordering number.

Example: SS-400-1-2**KN**

To order a knurled nut on an assembled fitting with PTFE ferrules, add **KT** to the fitting ordering number.

Example: SS-400-1-2**KT**

Male

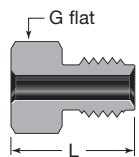

For use in female Swagelok end connections.

Tube OD	Basic Ordering Number	Dimensions	
		G	L
Dimensions, in.			
1/16	-1F2-1GC	1/4	0.38
1/8	-2F2-1GC	3/8	0.53
1/4	-4F2-1	1/2	0.62
1/2	-8F2-1	15/16	0.87

Tube OD	Basic Ordering Number	Dimensions	
		G	L
Dimensions, mm			
10	-10MF2-1	22	22.1
12	-12MF2-1	24	22.1

Replacement Parts

To order, add a material designator from the **How to Order** table on page 14.

Ferrules



Front

Tube OD	Basic Ordering Number
Dimensions, in.	
1/16	-103-1
1/8	-203-1
3/16	-303-1
1/4	-403-1
5/16	-503-1
3/8	-603-1
1/2	-813-1
5/8	-1013-1
3/4	-1213-1
7/8	-1413-1
1	-1613-1
1 1/4	-2003-1 ^①
1 1/2	-2403-1 ^①
2	-3203-1 ^①

^① Over 1 in. and over 25 mm stainless steel front ferrules are PFA coated. To order silver-plated front ferrules, add **-BL** to the basic ordering number.

Example: SS-2003-1BL

Tube OD	Basic Ordering Number
Dimensions, mm	
2	-2M3-1
3	-3M3-1
4	-4M3-1
6	-6M3-1
8	-8M3-1
10	-10M3-1
12	-12M3-1
14	-14M3-1
15	-15M3-1
16	-16M3-1
18	-18M3-1
20	-20M3-1
22	-22M3-1
25	-25M3-1
28	-28M3-1 ^①
30	-30M3-1 ^①
32	-32M3-1 ^①
38	-38M3-1 ^①
50	-50M3-1 ^①



Back

Tube OD	Basic Ordering Number
Dimensions, in.	
1/16	-104-1
1/8	-204-1
3/16	-304-1
1/4	-404-1
5/16	-504-1
3/8	-604-1
1/2	-814-1
5/8	-1014-1
3/4	-1214-1
7/8	-1414-1
1	-1614-1
1 1/4	-2004-1 ^①
1 1/2	-2404-1 ^①
2	-3204-1 ^①

^① Over 1 in. and over 25 mm stainless steel back ferrules are PFA coated. To order back ferrules without PFA coating, add **-WC** to the basic ordering number.

Example: SS-2004-1WC

Tube OD	Basic Ordering Number
Dimensions, mm	
2	-2M4-1
3	-3M4-1
4	-4M4-1
6	-6M4-1
8	-8M4-1
10	-10M4-1
12	-12M4-1
14	-14M4-1
15	-15M4-1
16	-16M4-1
18	-18M4-1
20	-20M4-1
22	-22M4-1
25	-25M4-1
28	-28M4-1 ^①
30	-30M4-1 ^①
32	-32M4-1 ^①
38	-38M4-1 ^①
50	-50M4-1 ^①

Replacement Parts

Nut-Ferrule Set and Ferrule Set

Use of Nuts and Ferrules

Using Swagelok nuts and ferrules on tube fittings or valves with tube end connections requires critical interaction of precision parts.

Swagelok nuts and ferrules are sold as replacement parts for use with only Swagelok bodies, fittings, valves, and hose products.

Sets are shown with arbors. One arbor holds five nut-ferrule sets or ten ferrule sets.

Nut-Ferrule Set



Ferrule Set



The nut-ferrule set contains one nut, one back ferrule, and one front ferrule.

To order, add a material designator to the basic ordering number. Please order nut-ferrule sets in multiples of five.

Example: **SS-400-NFSET**

Material	Designator
Brass	B
Carbon steel	S
316 stainless steel	SS

Tube OD	Basic Ordering Number
Dimensions, in.	
1/4	-400-NFSET
3/8	-600-NFSET
1/2	-810-NFSET
Dimensions, mm	
6	-6M0-NFSET
8	-8M0-NFSET
10	-10M0-NFSET
12	-12M0-NFSET

The ferrule set contains one front ferrule and one back ferrule. To order, add a material designator to the basic ordering number. Please order ferrule sets in multiples of ten.

Example: **SS-100-SET**

Material	Designator
Alloy 400	M
Aluminum	A
Brass	B
Carbon steel	S
Nylon	NY
PTFE	T
316 stainless steel	SS

Tube OD	Basic Ordering Number
Dimensions, in.	
1/16	-100-SET
1/8	-200-SET
3/16	-300-SET
1/4	-400-SET
5/16	-500-SET
3/8	-600-SET
1/2	-810-SET
Dimensions, mm	
6	-6M0-SET
8	-8M0-SET
10	-10M0-SET
12	-12M0-SET

Nut-Ferrule Package and Ferrule-Pak Package

To order the nut-ferrule package (50 nut-ferrule sets) or ferrule-pak package (100 front and back sets), contact your authorized Swagelok sales and service representative.

Nut-Ferrule Package

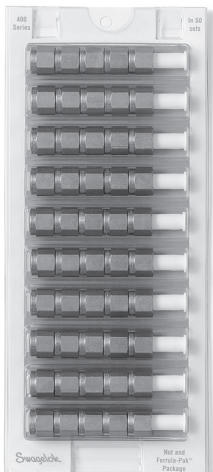

Ferrule-Pak Package

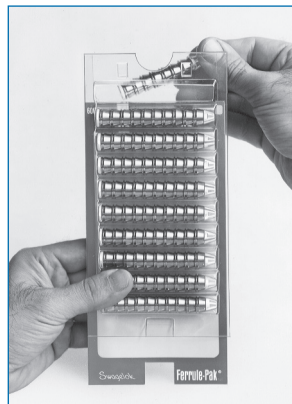

Replacement Parts

ISO/BSP Parallel Gaskets



Steel and Stainless Steel (RS Fitting)

RS fitting steel gaskets provide a seal with male ISO/BSP parallel threads.

The RS gasket is of a fluorocarbon FKM inner ring bonded to a carbon steel outer ring.

The RSD (DIN-style) gasket is a fluorocarbon FKM inner ring bonded to a stainless steel or carbon steel outer ring as recommended in ISO 1179-1973. It can be used with end connections designed in accordance with DIN 3852 Part 2.

The RSNB gasket is an all-metal 304L stainless steel gasket similar to DIN 7603 form D.

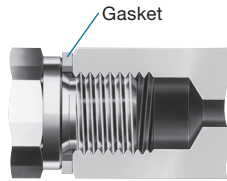

ISO Thread Size, in.	Ordering Number		
	RS Gasket ^①	RSD Gasket ^②	RSNB Gasket
1/8	S-2-RS-2V	SS-2-RSD-2V	304L-2-RSNB-2
1/4	S-4-RS-2V ^③	SS-4-RSD-2V	304L-4-RSNB-2
3/8	S-6-RS-2V ^③	SS-6-RSD-2V	304L-6-RSNB-2
1/2	S-8-RS-2V ^③	SS-8-RSD-2V	304L-8-RSNB-2
3/4	S-12-RS-2V	SS-12-RSD-2V	304L-12-RSNB-2
1	S-16-RS-2V	SS-16-RSD-2V	304L-16-RSNB-2
1 1/4	S-20-RS-2V	SS-20-RSD-2V	304L-20-RSNB-2
1 1/2	S-24-RS-2V	SS-24-RSD-2V	304L-24-RSNB-2

① Also available with a Buna inner ring. To order, replace **V** with **B** in the ordering number.
Example: S-2-RS-2**B**

② Also available with a carbon steel outer ring. To order, replace **SS** with **S** in the ordering number.
Example: **S**-8-RSD-2V

③ Also available with a stainless steel outer ring. To order, replace **S** with **SS** in the ordering number.
Example: **SS**-8-RS-2V



Copper (RP and RS Fitting)

The RP and RS fitting copper gasket provides a seal with male ISO/BSP parallel threads.

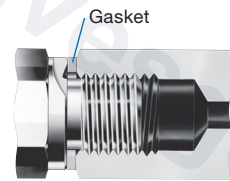

ISO Thread Size, in.	Ordering Number
1/8	CU-2-RP-2
1/4	CU-4-RP-2
3/8	CU-6-RP-2
1/2	CU-8-RP-2
3/4	CU-12-RP-2
1	CU-16-RP-2
1 1/4	CU-20-RP-2
1 1/2	CU-24-RP-2



Copper and Nickel (RG, Gauge Fitting)

The RG fitting gasket provides a seal on pressure gauges equipped with ISO/BSP parallel male threads.

ISO Thread Size, in.	Ordering Number	
	Copper	Nickel
1/4	CU-4-RG-2	NI-4-RG-2
3/8	CU-6-RG-2	NI-6-RG-2
1/2	CU-8-RG-2	NI-8-RG-2

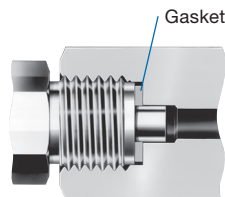

PTFE (RJ Fitting)

The RJ fitting PTFE gasket provides a seal with ISO/BSP parallel male threads.

ISO Thread Size, in.	Ordering Number
Regular Gaskets	
1/4	T-4-RJ-2
3/8	T-6-RJ-2
1/2	T-8-RJ-2
Thick Gaskets	
1/4	T-4-RJ-2-T
3/8	T-6-RJ-2-T
1/2	T-8-RJ-2-T

Contact your authorized Swagelok representative for gasket dimensions.

Replacement Parts

O-Rings



Buna N (O-Seal Straight Threads)

O-ring hardness is 70 durometer.

Thread Size in.	Uniform Size Number	Ordering Number
5/16-24	011	BN-70-OR-011
3/8-24	012	BN-70-OR-012
7/16-20	013	BN-70-OR-013
1/2-20	112	BN-70-OR-112
9/16-18	113	BN-70-OR-113
3/4-16	116	BN-70-OR-116
1 1/16-12	121	BN-70-OR-121
1 5/16-12	125	BN-70-OR-125

Buna N (O-Seal Pipe Threads)

O-ring hardness is 70 durometer.

NPT/ISO Pipe Size in.	Uniform Size Number	Ordering Number
1/8	013	BN-70-OR-013
1/4	113	BN-70-OR-113
3/8	116	BN-70-OR-116
1/2	118	BN-70-OR-118

Fluorocarbon FKM (Positionable Fittings, ISO/BSP Parallel Threads)

O-ring hardness is 90 durometer.

ISO Thread Size in.	Uniform Size Number	Ordering Number
1/8	502 ^①	FSP-90-OR-502
1/4	111	FCBR-90-OR-111
3/8	113	FCBR-90-OR-113
1/2	508 ^①	FCBR-90-OR-508
3/4	119	FCBR-90-OR-119
1	217	FCBR-90-OR-217

^① Not a uniform O-ring size.

Fluorocarbon FKM (SAE/MS Straight Threads)

O-ring hardness is 90 durometer.

SAE/MS Thread Size in.	Uniform Size Number	Ordering Number
5/16-24	902	FCBR-90-OR-902
3/8-24	903	FCBR-90-OR-903
7/16-20	904	FCBR-90-OR-904
1/2-20	905	FCBR-90-OR-905
9/16-18	906	FCBR-90-OR-906
3/4-16	908	FCBR-90-OR-908
7/8-14	910	FCBR-90-OR-910
1 1/16-12	912	FCBR-90-OR-912
1 3/16-12	914	FCBR-90-OR-914
1 5/16-12	916	FCBR-90-OR-916
1 5/8-12	920	FCBR-90-OR-920
1 7/8-12	924	FCBR-90-OR-924
2 1/2-12	932	FCBR-90-OR-932

Tools and Accessories

Hydraulic Swaging Units

Swagelok hydraulic swaging units preswage Swagelok ferrules onto tubing prior to assembly and provide Swagelok tube fitting connections that are 100 % gaugeable upon initial installation. Multihead hydraulic and air-actuated hydraulic swaging units:

- Place no initial strain on fitting body threads or on body seal surfaces
- Are available with interchangeable fractional and metric tooling
- Fit neatly in a rugged plastic carrying case
- Reduce assembly and installation time and operator error.

Multihead Hydraulic Swaging Unit (MHSU)

- Is available in two unit sizes, with tooling for:
 - 1/2 to 1 in. and 12 to 25 mm tubing and tube adapters
 - 1 to 2 in. and 25 to 50 mm tubing
- **Must** be used to install 1 1/4, 1 1/2, and 2 in. and 28, 30, 32, 38, and 50 mm Swagelok tube fittings
- Is standard with a tube marking feature to indicate when tube is properly bottomed in the unit
- Is available with a support base (as shown). See **Ordering Information**, page 63.

The MHSU cannot be used for Alloy 2507 tubing 1/2 in. and under. For 5/8 and 3/4 in. alloy 2507 tubing, order the 1 in./25 mm and over unit and alloy 2507 tooling kit and gap inspection gauges.

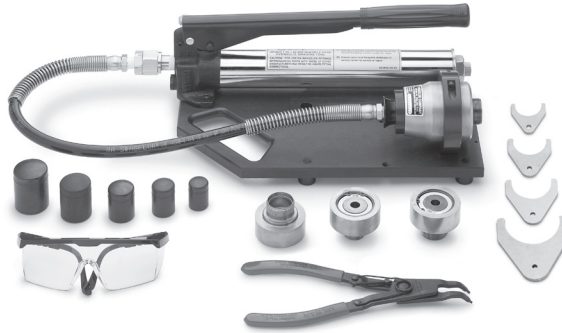

MHSU Unit Components

- Multihead hydraulic swaging unit
- Hydraulic hose—2 ft (0.6 m) with all units **except** 1 in./25 mm and over unit without support base, which contains 6 ft (1.8 m) hose
- Retaining ring pliers
- Safety glasses
- Operating instructions
- Carrying case

Tooling Kit Components

- Die head sets for Swagelok tube fitting sizes:
 - Fractional, up to 1 in.—1/2, 5/8, 3/4, 7/8, and 1 in.
 - Fractional, 1 in. and over—1, 1 1/4, 1 1/2, and 2 in.
 - Metric, up to 25 mm—12, 14, 15, 16, 18, 20, 22, and 25 mm
 - Metric, 25 mm and over—25, 28, 30, 32, and 38 mm
 - 50 mm tooling available separately
- Gap inspection gauges
- Chamfer block (up to 1 in./25 mm sizes only)

Recommended Minimum Wall Thickness of Tubing for use with the MHSU

Swagelok Tube Fittings		
Tooling Size	Steel, Alloy 400 Grade 2 Titanium	Stainless Steel, Alloy (C-276, 600, 6-moly, 825 and 625)
	Tubing Wall	
Dimensions, in.		
1/2	0.049	0.065
5/8	0.065	
3/4		
7/8		
1		
1 1/4	0.083	0.095
1 1/2		0.109
2		

Use of tubing below the recommended minimum wall thickness may result in the tube sticking in the die head.

Swagelok Tube Fittings		
Tooling Size	Steel, Alloy 400 Grade 2 Titanium	Stainless Steel, Alloy (C-276, 600, 6-moly, 825 and 625)
	Tubing Wall	
Dimensions, mm		
12	1.5	1.5
14		
15		
16		
18		
20	2.0	2.0
22		
25		
28	2.2	2.2
30		
32		
38		
50		

Technical Data

- Dimensions—MHSU case
22 in. (55.9 cm) high, 24 in. (61.0 cm) wide, 8.75 in. (22.2 cm) deep
- Weight
Up to 1 in./25 mm MHSU in case with tooling kit and support base—40 lb (18.1 kg)
1 in./25 mm and over MHSU in case with tooling kit and support base—55 lb (24.9 kg)
- Construction
High-strength stainless steel tooling for durability and corrosion resistance

See next page for **Ordering Information**.

Tools and Accessories

Hydraulic Swaging Units MHSU Ordering Information

Select an ordering number.

Ordering Numbers	
MHSU Unit	
Up to 1 in./25 mm sizes	MS-MHSU-U-E
1 in./25 mm and over sizes	MS-MHSU-O-E
MHSU Unit with Tooling Kit	
Fractional up to 1 in. sizes	MS-MHSU-U-E-FKIT-M
Fractional 1 in. and over sizes	MS-MHSU-O-E-FKIT-M
Metric up to 25 mm sizes	MS-MHSU-U-E-MKIT-M
Metric 25 to 38 mm ^① sizes	MS-MHSU-O-E-MKIT-M

① 50 mm tooling available separately.

Support Base

Add **-B** to the ordering number.

Examples: MS-MHSU-U-E-**B**
MS-MHSU-U-E-FKIT-M-**B**

Operating Instructions

MHSU ordering numbers include English-language instructions. For other languages, visit swagelok.com.

See the Swagelok *Multihead Hydraulic Swaging Unit (MHSU) Setup and Operating Instructions*, [MS-12-37](#), for information about using the MHSU.

Accessories

Additional and replacement gap inspection gauges are available. See page 67.

See the table below for replacement retaining rings, pliers, and chamfer blocks.

MHSU Unit	Ordering Number
Retaining Ring	
Up to 1 in./25 mm sizes	MS-MHSU-N5000-200-H
1 in./25 mm and over sizes	MS-MHSU-N5000-315-H
Retaining Ring Pliers	
Up to 1 in./25 mm sizes	MS-MHSU-0504
1 in./25 mm and over sizes	MS-MHSU-0700

Chamfer Blocks	Ordering Number
in.	
1/2	MS-CB-810
5/8	MS-CB-1010
3/4	MS-CB-1210
7/8	MS-CB-1410
1	MS-CB-1610
mm	
12	MS-CB-12M0
14	MS-CB-14M0
15	MS-CB-15M0
16	MS-CB-16M0
18	MS-CB-18M0
20	MS-CB-20M0
22	MS-CB-22M0
25	MS-CB-25M0

Tooling Kits

Up to 1 in./25 mm

Tube OD	Ordering Number
Dimensions, in.	
1/2	MS-MHSUT-U-810-M
5/8	MS-MHSUT-U-1010-M
3/4	MS-MHSUT-U-1210-M
7/8	MS-MHSUT-U-1410-M
1	MS-MHSUT-U-1610-M
Alloy 2507 Tubing	
5/8	MS-MHSUT-O-2507-1010-M
3/4	MS-MHSUT-O-2507-1210-M
Dimensions, mm	
12	MS-MHSUT-U-12M0-M
14	MS-MHSUT-U-14M0-M
15	MS-MHSUT-U-15M0-M
16	MS-MHSUT-U-16M0-M
18	MS-MHSUT-U-18M0-M
20	MS-MHSUT-U-20M0-M
22	MS-MHSUT-U-22M0-M
25	MS-MHSUT-U-25M0-M

1 in./25 mm and Over

Tube OD	Ordering Number
Dimensions, in.	
1	MS-MHSUT-O-1610-M
1 1/4	MS-MHSUT-O-2000-M
1 1/2	MS-MHSUT-O-2400-M
2	MS-MHSUT-O-3200-M
Dimensions, mm	
25	MS-MHSUT-O-25M0-M
28	MS-MHSUT-O-28M0-M
30	MS-MHSUT-O-30M0-M
32	MS-MHSUT-O-32M0-M
38	MS-MHSUT-O-38M0-M
50	MS-MHSUT-O-50M0-M

Tools and Accessories

Hydraulic Swaging Units

Air-Actuated

Hydraulic Swaging Unit (AHSU)

- Requires only one unit with interchangeable tooling to swage 1/4 to 1/2 in. and 6 to 12 mm Swagelok tube fitting ferrule sizes
- Requires no threading of nut on or off the tooling

The AHSU cannot be used for alloy 2507 tubing or for medium-pressure tubing.

AHSU Unit Components

- Air-actuated hydraulic swaging unit
- Hex key
- Adapter plates—for tube fittings smaller than 1/2 in. or 12 mm
- Safety glasses
- Gap inspection gauges
- Operating instructions
- Carrying case

Tooling Kit Components

- Die head sets and gap inspection gauges for Swagelok tube fitting sizes:
 - Fractional—1/4, 3/8, and 1/2 in.
 - Metric—6, 8, 10, and 12 mm

Technical Data

- Dimensions—AHSU case
19 in. (48.3 cm) high, 15.5 in. (39.4 cm) wide, 7.5 in. (19.0 cm) deep
- Weight
AHSU in case with tooling kit—28 lb (12.7 kg)
- Power requirements
20 to 70 psig (1.4 to 4.8 bar) regulated shop air, depending on fitting size and material
- Construction
High-strength stainless steel tooling for durability and corrosion resistance
- Air inlet port
1/4 in. Swagelok tube fitting

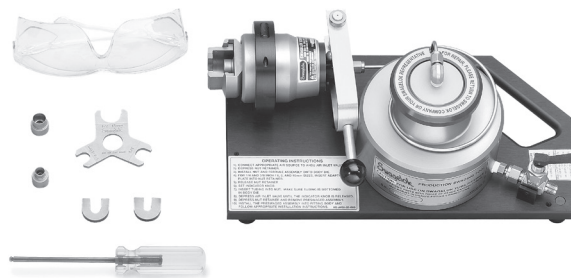

AHSU Ordering Information

Select an ordering number.

Ordering Numbers	
AHSU Unit	
AHSU only	MS-AHSU-E
AHSU Unit with Tooling Kit	
1/4, 3/8, 1/2 in. sizes	MS-AHSU-E-FKIT
6, 8, 10, 12 mm sizes	MS-AHSU-E-MKIT

Tooling Kits

Tube OD	Ordering Number
Dimensions, in.	
1/4	MS-AHSUT-400-1
3/8	MS-AHSUT-600-1
1/2	MS-AHSUT-810-1
Dimensions, mm	
6	MS-AHSUT-6M0-1
8	MS-AHSUT-8M0-1
10	MS-AHSUT-10M0-1
12	MS-AHSUT-12M0-1

Operating Instructions

AHSU ordering numbers include English-language instructions. For other languages, visit swagelok.com.

Accessories

Additional and replacement gap inspection gauges are available. See page 67.

Refer to *Air-Actuated Hydraulic Swaging Unit (AHSU) Setup and Operating Instructions*, [MS-12-38](#), for information about using the AHSU.

High-Volume Swaging Unit (HVSU)

The Swagelok high-volume swaging unit (HVSU) is designed to easily preswage a Swagelok nut and ferrules

onto stainless steel tubing. The pneumatically driven and electronically controlled semiautomatic unit uses sensors to start and stop the process for consistent preswaging results.

Refer to *High-Volume Swaging Unit* catalog, [MS-02-441](#), for additional information.



Tools and Accessories

Preswaging Tools

For Swagelok tube fitting installations in close quarters, the Swagelok preswaging tool is a convenient accessory.



Features

- Preswages ferrules onto the tube
- Enables the installer to work in a more open, safe area
- Makes it possible to complete the installation by following retightening instructions for Swagelok tube fittings

A gaugeable preswaging tool is available in the following sizes: 1/4, 3/8, 1/2, and 5/8 inch and 6, 8, 10, 12, and 16 mm. All other sizes are not gaugeable. The gaugeable feature allows the installer to quickly measure the gap between the nut and the fitting body with a standard Swagelok gap gauge during initial installation. The gaugeable preswage tool is distinguished from the standard tool by the addition of a colored band located between the wrench pad and the Swagelok tube fitting end.



Tube OD	Ordering Number
Dimensions, in.	
Female Nut	
1/16	MS-ST-100
1/8	MS-ST-200
3/16	MS-ST-300
1/4 ^②	MS-ST-400GA
5/16	MS-ST-500
3/8 ^②	MS-ST-600GA
1/2 ^②	MS-ST-810GA
5/8 ^{①②}	MS-ST-1010GA
5/8 (alloy 2507)	MS-ST-2507-1010
3/4 ^①	MS-ST-1210
3/4 (alloy 2507)	MS-ST-2507-1210
7/8	MS-ST-1410
1	MS-ST-1610
Male Nut	
1/16	MS-ST-1F0
1/2	MS-ST-8F0

Tube OD	Ordering Number
Dimensions, mm	
Female Nut	
3	MS-ST-3M0
4	MS-ST-4M0
6 ^①	MS-ST-6M0GA
8 ^①	MS-ST-8M0GA
10 ^①	MS-ST-10M0GA
12 ^①	MS-ST-12M0GA
14	MS-ST-14M0
15	MS-ST-15M0
16 ^①	MS-ST-16M0GA
18	MS-ST-18M0
20	MS-ST-20M0
22	MS-ST-22M0
25	MS-ST-25M0

① Ordering numbers containing **GA** at the end are gaugeable preswage tools, all others are non-gaugeable preswage tools.

① For alloy 2507 tubing, use the preswaging tool for the appropriate tube OD and with **2507** in the ordering number.

② Ordering numbers containing **GA** at the end are gaugeable preswage tools, all others are non-gaugeable preswage tools.

Tools and Accessories

Wrenches

Tee Wrench

The tee wrench provides positive backup support when installing Swagelok union tees and crosses.



Features

- Allows user to hold fitting body firmly and precisely
- Is available in a variety of sizes
- Fits and carries easily in tool box, pouch, or belt
- Head and handle constructed of stainless steel
- Features a cushioned vinyl grip and generous gripping area for handle
- Holds tee in various orientations

Ordering Information

For Swagelok Gaugeable Union Tees and Crosses			
Tube OD	Ordering Number	Tee	Cross
1/4 in. and 6 mm	MS-TW-4	✓	✓
5/16 and 3/8 in. and 8 mm	MS-TW-6	✓	✓
10 mm	MS-TW-10M	✓	①
1/2 in. and 12 mm	MS-TW-8	✓	✓

① Use **MS-TW-8** on 10 mm Swagelok crosses.

Tools and Accessories

Gap Inspection Gauges

Swagelok gap inspection gauges assure the installer or inspector that the fitting has been sufficiently pulled up on initial installation, whether using a Swagelok multihead hydraulic swaging unit (MHSU), page 62, or air-actuated hydraulic swaging unit (AHSU), page 64, or wrench tightening. All metal Swagelok tube fittings are gaugeable, with the exception of a few forged bodies in aluminum.



For Installation Using the AHSU

Fitting Size		Ordering Number
in.	mm	
Female Nut		
1/4, 3/8, 1/2	—	MS-AHSU-IG-468
—	6, 8, 10, 12	MS-AHSU-IG-612M

For Installation Using the MHSU

Fitting Size		Ordering Number
in.	mm	
Female Nut		
1/2 ^①	12	MS-MHSU-IG-810
5/8 ^②	14, 15, 16	MS-MHSU-IG-1010
5/8 (alloy 2507)	—	MS-MHSU-IG-2507-1010
3/4 ^②	18	MS-MHSU-IG-1210
3/4 (alloy 2507)	—	MS-MHSU-IG-2507-1210
7/8	20, 22	MS-MHSU-IG-1410
1	25	MS-MHSU-IG-1610-1
—	28	MS-MHSU-IG-28M0-1
—	30	MS-MHSU-IG-30M0-1
1 1/4	—	MS-MHSU-IG-2000-2
—	32	MS-MHSU-IG-32M0-1
—	38	MS-MHSU-IG-38M0-1
1 1/2	—	MS-MHSU-IG-2400-1
—	50	MS-MHSU-IG-50M0-1
2	—	MS-MHSU-IG-3200-1

① The MHSU cannot be used for alloy 2507 tubing 1/2 in. and under.

② For 5/8 and 3/4 in. alloy 2507 tubing, order the 1 in. (25 mm) and over unit and alloy 2507 tooling and gauge.

For Installation Using a Wrench

Fitting Size		Ordering Number
in.	mm	
Female Nut		
1/16	—	MS-IG-100
1/8	2, 3	MS-IG-200
3/16	4	MS-IG-300
1/4	6	MS-IG-400
1/4, 3/8, 1/2	6, 12	MS-IG-468
1/4, 1/2	6, 8, 10, 12	MS-IG-612M
5/16	8	MS-IG-500
3/8	—	MS-IG-600
—	10	MS-IG-10M0
1/2	12	MS-IG-810
5/8	14, 15, 16	MS-IG-1010
5/8 (alloy 2507)	—	MS-IG-2507-1010
3/4	18	MS-IG-1210
3/4 (alloy 2507)	—	MS-IG-2507-1210
7/8	20, 22	MS-IG-1410
1	25	MS-IG-1610
Male Nut		
1/16	—	MS-IG-1F0
1/8	2, 3	MS-IG-2F0

Depth Marking Tools



Swagelok depth marking tools help ensure that tubing is bottomed on the shoulder inside the Swagelok tube fitting body.

Tube OD	Ordering Number
Dimensions, in.	
1/4	MS-DMT-400
3/8	MS-DMT-600
1/2	MS-DMT-810
5/8	MS-DMT-1010
3/4	MS-DMT-1210
7/8	MS-DMT-1410
1	MS-DMT-1610

Tube OD	Ordering Number
Dimensions, mm	
6	MS-DMT-6M0
8	MS-DMT-8M0
10	MS-DMT-10M0
12	MS-DMT-12M0
16	MS-DMT-16M0
18	MS-DMT-18M0

Tools and Accessories

Bulkhead Retainers

By using the bulkhead retainer, one person can tighten the jam nut on side A for initial bulkhead fitting installation. Now tubing can be connected to side A and B by one person with one wrench, because the bulkhead retainer acts as a backup wrench.

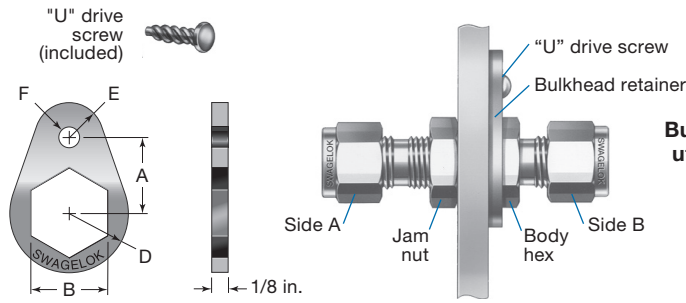

Bulkhead fitting installation utilizing bulkhead retainer

Fitting Size		Ordering Number	Dimensions, in.					Drill Hole Dia	"U" Drive Screw Size	Drill Number
			A	B	D	E	F			
in.	mm									
1/16	—	SS-102-61F	3/8	5/16	5/16	5/32	5/32	0.120	6-3/8	31
1/8	—	SS-202-61F	1/2	1/2	13/32	7/32				
3/16	3, 4	SS-302-61F	9/16	9/16	15/32	1/4				
1/4	6	SS-402-61F	5/8	5/8	1/2	9/32				
5/16	—	SS-502-61F	11/16	11/16	9/16	5/16				
—	8	SS-8M2-61F	11/16	18 mm	9/16	5/16				
3/8	—	SS-602-61F	3/4	3/4	5/8	11/32	7/32	0.144	10-1/2	27
—	10	SS-10M2-61F	15/16	22 mm	3/4	13/32				
1/2	12	SS-812-61F	15/16	15/16	3/4	13/32				
5/8	15, 16	SS-1012-61F	1	1 1/16	13/16	13/32				
3/4	18	SS-1212-61F	1 1/16	1 3/16	29/32	15/32				
7/8	—	SS-1412-61F	1 1/8	1 5/16	1 1/32	17/32				
1	—	SS-1612-61F	1 9/32	1 5/8	1 5/32	9/16				

Inserts for Soft Plastic Tubing

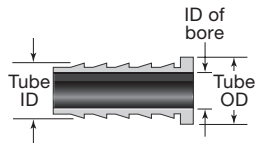

Swagelok inserts help secure soft plastic tubing being used with standard Swagelok tube fittings. To determine the correct size of the Swagelok insert to be used, check both outside diameter and inside diameter of the plastic tubing.

For a complete line of hose connectors for soft plastic tubing, refer to Swagelok *Hose and Flexible Tubing* catalog, [MS-01-180](#).

Ordering Information

Add the insert material designator to the basic ordering number.

Example: **B-305-2**

Material	Designator
Alloy 400	M
Aluminum	A
Brass	B
Carbon steel	S
Stainless steel	SS

Tube OD	Tube ID	Bore ID	Basic Ordering Number
Dimensions, in.			
3/16	1/8	0.09	-305-2
1/4	1/8	0.09	-405-2
	0.17	0.11	-405-170
5/16	3/16	0.14	-405-3
	1/8	0.09	-505-2
	1/4	0.19	-505-4
3/8	3/16	0.12	-605-3
	1/4	0.19	-605-4
1/2	1/4	0.19	-815-4
	3/8	0.31	-815-6
5/8	3/8	0.31	-1015-6
	1/2	0.44	-1015-8
3/4	1/2	0.44	-1215-8
	5/8	0.56	-1215-10
1	3/4	0.69	-1615-12
Dimensions, mm			
6	4	2.8	-6M5-4M
8	6	4.4	-8M5-6M
10	8	6.4	-10M5-8M
12	8	6.4	-12M5-8M
	10	8.3	-12M5-10M

Gaugeability

On initial installation, the Swagelok gap inspection gauge assures the installer or inspector that a fitting has been sufficiently tightened.

Position the Swagelok gap inspection gauge next to the gap between the nut and body.

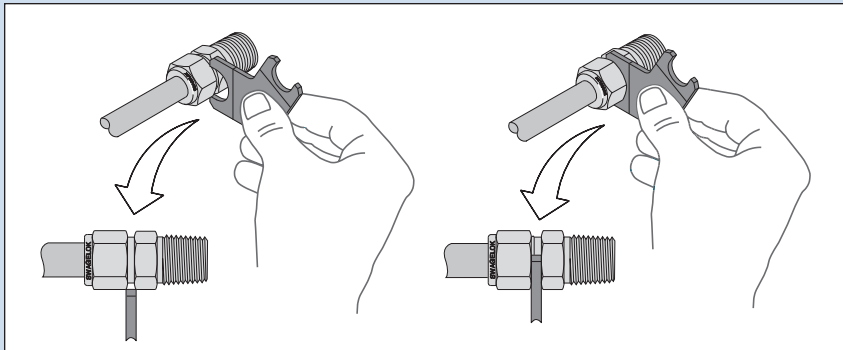

If the gauge **will not** enter the gap, the fitting is sufficiently tightened.

If the gauge **will** enter the gap, additional tightening is required.

⚠ Always depressurize a system before adjusting the tightness of a tube fitting connection.

Installation Instructions

Swagelok tube fittings 1 in./25 mm and smaller can be installed quickly, easily, and reliably with simple hand tools. Over 1 in./25 mm sizes require use of a hydraulic swaging unit to swage the ferrules onto the tubing.

Safety Precautions

- Do not bleed system by loosening fitting nut or fitting plug.
- Do not assemble or tighten fittings when system is pressurized.
- Make sure that the tubing rests firmly on the shoulder of the tube fitting body before tightening the nut.
- Use the correct Swagelok gap inspection gauge to ensure sufficient pull-up upon initial installation.
- Always use proper thread sealants on tapered pipe threads.
- Do not mix materials or fitting components from various manufacturers—tubing, ferrules, nuts, and fitting bodies.
- Never turn fitting body. Instead, hold fitting body and turn nut.
- Avoid unnecessary disassembly of unused fittings.
- Use only long reducers in female Swagelok end connections.

See the instructions starting on the next page for installation of Swagelok tube fittings, O-seal male connectors, caps and plugs, port connectors, tube adapters, positionable elbows and tees, weld fittings, depth marking tool, and preswaging tool.

Tubing Considerations

- Metal tubing material should be softer than fitting material. For example, stainless steel tubing should not be used with brass fittings.
- When tubing and fittings are made of the same material, tubing must be fully annealed.
- Always use an insert with extremely soft or pliable plastic tubing.
- Extremes of wall thickness should always be checked against the suggested minimum and maximum wall thickness limitations.
- Surface finish is very important to proper sealing. Tubing with any kind of depression, scratch, raised portion, or other surface defect will be difficult to seal, particularly in gas service.
- Tubing that is oval and will not easily fit through fitting nuts, ferrules, and bodies should never be forced into the fitting.

Refer to *Tubing Data* catalog, [MS-01-107](#), for additional information about tubing selection.

Installation Instructions

Swagelok Tube Fittings Up to 1 in./25 mm

These instructions apply both to traditional fittings and to fittings with the advanced back-ferrule geometry.

Safe practices and proper installation are imperative to the performance of the Swagelok tube fitting, especially in critical applications.

For 5/8, 3/4, 7/8 and 1 in.; 16, 18, 20, 22 and 25 mm tube fittings, in all materials except for aluminum and brass, it is a best practice to preswage the ferrules onto the tube using a Swagelok multihead hydraulic swaging unit (MHSU) to lower installation time and increase ease of installation (see Multihead Hydraulic Swaging Unit (MHSU), Setup and Operating Instructions, [MS-12-37](#)).

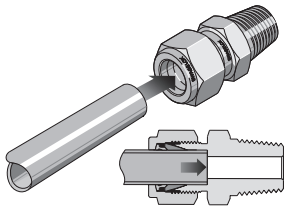

Fully insert the tube into the fitting and against the shoulder; rotate the nut finger-tight.

High-pressure applications and high safety-factor systems: Further tighten the nut until the tube will not turn by hand or move axially in the fitting.

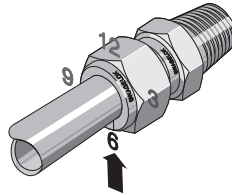

Mark the nut at the 6 o'clock position.

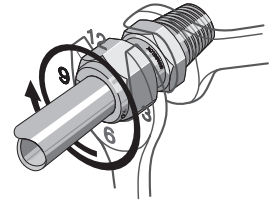

While holding the fitting body steady, tighten the nut one and one-quarter turns to the 9 o'clock position.

For 1/16, 1/8, and 3/16 in.; 2, 3, and 4 mm tube fittings, tighten the nut only three-quarters turn to the 3 o'clock position.

Swagelok Tube Fittings Over 1 in./25 mm

1. Preswage the ferrules onto the tube using a Swagelok multihead hydraulic swaging unit (MHSU).
2. Apply the lubricant packaged with the fitting lightly to the body threads and the rear surface of the back ferrule. For gas service also apply lightly to the front angled surface of the front ferrule.
3. Insert the tube with preswaged ferrules into the fitting until the front ferrule seats against the fitting body; rotate the nut finger-tight.
4. Mark the nut at the 6 o'clock position.

5. While holding the fitting body steady, tighten the nut one-half turn to the 12 o'clock position.

Use the Swagelok MHSU gap inspection gauge to ensure that the fitting has been tightened sufficiently.

Reassembly—All Sizes

You may disassemble and reassemble Swagelok tube fittings many times.

⚠ Always depressurize the system before disassembling a Swagelok tube fitting.

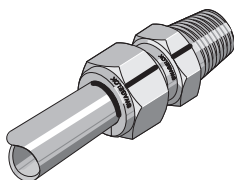

Prior to disassembly, mark the tube at the back of the nut; mark a line along the nut and fitting body flats.

Use these marks to ensure that you return the nut to the previously pulled-up position.

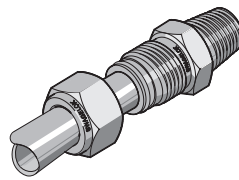

Insert the tube with preswaged ferrules into the fitting until the front ferrule seats against the fitting body.

Over 1 in./25 mm sizes: If needed, reapply lubricant lightly to the body threads and the rear surface of the back ferrule.

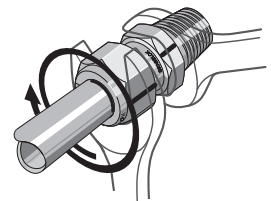

While holding the fitting body steady, rotate the nut with a wrench to the previously pulled-up position, as indicated by the marks on the tube and flats. At this point, you will feel a significant increase in resistance. Tighten the nut slightly.

⚠ Do not use the Swagelok gap inspection gauge with reassembled fittings.

O-Seal Male Connectors

1. Turn the O-seal connector into the female end until it is finger-tight.
2. Tighten the O-seal connector until it makes metal-to-metal contact with the face of the female end.
3. Tighten slightly with a wrench.

Installation Instructions

Caps and Plugs

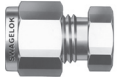

Caps

See Swagelok tube fitting installation and reassembly, page 70.



Plugs

While holding fitting body steady, tighten the plug one-quarter turn from the finger-tight position.

For 1/16, 1/8, and 3/16 in.; 2, 3, and 4 mm tube fittings, tighten the plug one-eighth turn.
For over 1 in./25 mm tube fittings, tighten the plug one-quarter turn.

⚠ Do not use the Swagelok gap inspection gauge with plug assemblies.

Reassembly

You may disassemble and reassemble Swagelok plugs many times. Make subsequent connections by slightly tightening with a wrench after snugging the nut by hand.

Port Connectors

Connect the machined ferrule end **before** connecting the tube adapter end.

Machined Ferrule End

1. Remove the nut and ferrules from the Swagelok end connection. Discard the ferrules.

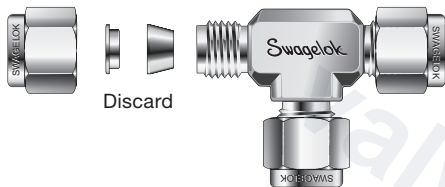

2. Slip the nut over the machined ferrule end of the port connector.

Over 1 in./25 mm sizes: The nut is preassembled on the port connector.

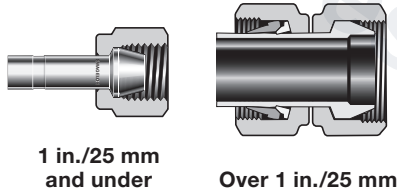

3. Insert the port connector into the end connection and finger-tighten the nut.

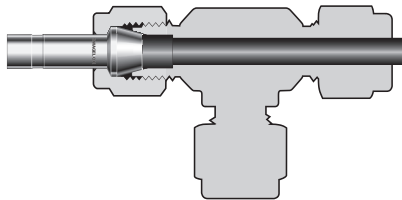

4. While holding fitting body steady, tighten the nut one-quarter turn.

For 1/16, 1/8, and 3/16 in.; 2, 3, and 4 mm tube fittings, tighten the nut one-eighth turn.

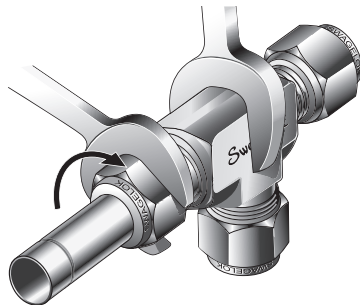

⚠ Do not use the Swagelok gap inspection gauge with machined ferrule ends.

Reassembly

You may disassemble and reassemble Swagelok port connectors many times. Make subsequent connections by slightly tightening with a wrench after snugging the nut by hand.

Tube Adapter End

5. Insert the tube adapter until it rests firmly on the shoulder of the Swagelok tube fitting body. Finger-tighten the nut.

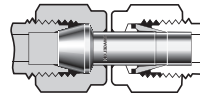

Over 1 in./25 mm sizes: Remove and discard the nut and ferrules from the end connection, then insert the tube adapter.

6. Mark the nut at the 6 o'clock position. While holding fitting body steady, tighten the nut one and one-quarter turns to the 9 o'clock position.

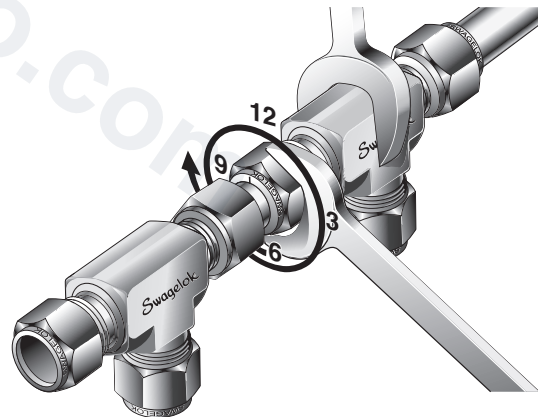

For 1/16, 1/8, and 3/16 in.; 2, 3, and 4 mm tube fittings, tighten the nut three-quarters turn to the 3 o'clock position.

For preswaged over 1 in./25 mm and over tube fittings, tighten the nut one-half turn to the 12 o'clock position.

⚠ Do not use the Swagelok gap inspection gauge with preswaged tube adapter connections over 1 in./25 mm.

Reassembly

See Swagelok tube fitting reassembly, page 70.

Installation Instructions

Positionable Elbows and Tees

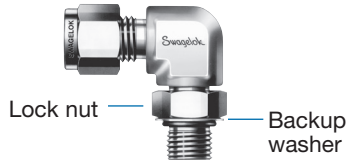

1. Turn the positionable end into the female fitting until the metal backup washer contacts the face of the fitting.
2. Turn the positionable end out of the female fitting (not more than one turn) until the Swagelok tube fitting end is positioned properly.
3. While holding fitting body steady, tighten the lock nut until the metal backup washer contacts the face of the fitting.

Tube Adapters

Safe practices and proper installation are imperative to the performance of the Swagelok tube fitting, especially in critical applications.

For 5/8, 3/4, 7/8 and 1 in.; 16, 18, 20, 22 and 25 mm tube fittings, in all materials except for aluminum and brass, it is a best practice to preswage the ferrules onto the tube adapter using a Swagelok multihead hydraulic swaging unit (MHSU) to lower installation time and increase ease of installation (see Multihead Hydraulic Swaging Unit (MHSU), Setup and Operating Instructions, [MS-12-37](#)).

Fig. 1

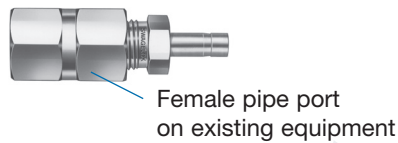

Fig. 2



Up to 1 in./25 mm

1. Install the end opposite the tube adapter end (Fig. 1).
2. Insert the tube adapter into the Swagelok tube fitting. Make sure that the tube adapter rests firmly on the shoulder of the tube fitting body and that the nut is finger-tight (Fig. 2).
3. Mark the nut at the 6 o'clock position.
4. While holding fitting body steady, tighten the nut one and one-quarter turns to the 9 o'clock position.

For 1/16, 1/8, and 3/16 in.; 2, 3, and 4 mm tube fittings, tighten the nut only three-quarters turn to the 3 o'clock position.

Over 1 in./25 mm

Swagelok tube adapters over 1 in./25 mm are furnished with nuts and preswaged ferrules.

To assemble, follow steps 2 through 5 of the Swagelok tube fittings over 1 in./25 mm assembly instructions, page 70.

⚠ Do not use the Swagelok gap inspection gauge with preswaged tube adapter connections over 1 in./25 mm.

Reassembly

See Swagelok tube fitting reassembly, page 70.

AN Thread Swivel Nut

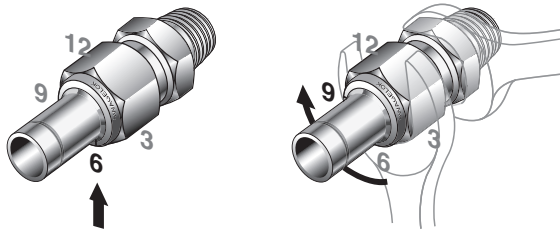

Note: Swagelok nut and ferrules removed from the illustration for clarity.

1. Thread the AN swivel nut of the female AN assembly onto the male AN body until it is finger-tight.
2. Mark a line along the AN swivel nut and male AN body, parallel with the axis of the assembly, at the 6 o'clock position.
3. Hold the male AN body steady and tighten the AN swivel nut with a wrench one-quarter turn past finger tight, to the 9 o'clock position.

Note: For carbon steel fittings, assemble nut to finger-tight, then tighten to torque per SAE J514, Hydraulic Tube Fittings.

Reassembly instructions:

There are a maximum of 10 re-assemblies per SAE J514.

1. Prior to disassembly, mark a line along the AN swivel nut and male AN body, parallel with the axis of the assembly.
2. For reassembly, rotate the nut with a wrench to the previously pulled-up position, as indicated by the marks on the AN swivel nut and male AN body. At this point, you will feel a significant increase in resistance. Tighten the nut slightly.

Note: For carbon steel fittings, reassemble the nut to finger-tight, then tighten to torque per SAE J514.

Installation Instructions

Weld Fittings

Welding Precautions for Swagelok Tube Fittings with Weld End Connections

1. Remove the nut and ferrules.
 2. Turn a Swagelok tube fitting plug or another nut onto the fitting so that it is finger-tight. This protects the threads and sealing components.
 3. Provide a suitable heat sink to dissipate the heat.
 4. Tack weld at four positions 90° apart to hold the fitting in place and to ensure alignment and concentricity of the components.
 5. Complete the weld.
 6. Remove the plug or nut and replace the nut and ferrules.
- ⚠ Caution: When welding carbon steel fittings, the heat often removes the protective oil from the threads. It is important to apply another lubricant, such as Goop™ thread lubricant.**

Depth Marking Tool

Fig. 1



Fig. 2



1. Insert cleanly cut, fully deburred tube into the depth marking tool (DMT) until the tube is against the shoulder of the tool. Using a pen or pencil, mark the tube at the top of the DMT (Fig. 1).
2. Remove the tube from the DMT and insert it into the Swagelok fitting until it is against the shoulder of the fitting body (Fig. 2). Rotate the nut finger-tight. If any portion of the mark on the tube can be seen above the fitting nut, the tube is not fully inserted into the fitting.
3. While holding the fitting body steady, follow Swagelok tube fitting installation instructions, page 70.

Non-Gaugeable Preswaging Tool

Fig. 1

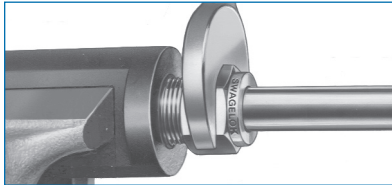

Fig. 2

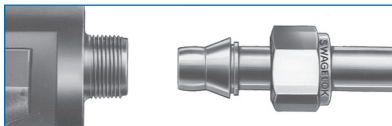
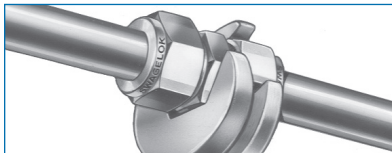

Fig. 3



NOTE: These instructions apply only to non-gaugeable preswaging tools. Tool will not have a colored band and the ordering number does not contain GA.

1. Install the Swagelok nut and ferrules onto the preswaging tool.
 2. Insert the tube into the preswaging tool.
 3. Make sure that the tube rests firmly on the shoulder of the preswaging tool body and that the nut is finger-tight.
 4. Mark the nut at the 6 o'clock position.
 5. While holding the preswaging tool steady, tighten the nut one and one-quarter turns to the 9 o'clock position.
For 1/16, 1/8, and 3/16 in.; 2, 3, and 4 mm tube fittings, tighten the nut only three-quarters turn to the 3 o'clock position (Fig. 1).
 6. Loosen the nut.
 7. Remove the tube with preswaged ferrules from the preswaging tool. If the tube sticks in the preswaging tool, remove the tube by gently rocking it back and forth. Do not turn the tube (Fig. 2).
 8. Insert the tube with preswaged ferrules into the fitting until the front ferrule seats against the fitting body.
 9. While holding the fitting body steady, rotate the nut with a wrench to the previously pulled-up position; at this point, you will feel a significant increase in resistance.
 10. Tighten the nut slightly (Fig. 3).
- ⚠ Do not use the Swagelok gap inspection gauge with fittings that were assembled with a non-gaugeable preswaging tool.**

Installation Instructions

Tools Required for Gaugeable Preswaging Tool Instructions

Fig. 1



Fig. 2



Fig. 3



Fig. 4



1. Gaugeable preswage tool will have a colored band (Fig. 1).
Gaugeable tools are available in sizes 1/4, 3/8, 1/2, and 5/8 in. (6, 8, 10, 12, and 16 mm)
2. Body wrench and nut wrench (Fig. 2).
3. Standard gap gauge for standard assembly (Fig. 3).
4. Severe-service gap gauge for severe service assembly (Fig. 4).

Gaugeable Preswaging Tool Instructions

Fig. 5

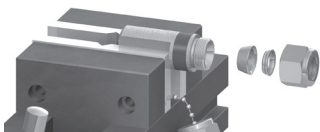

Fig. 6

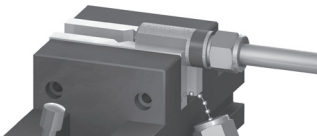

Fig. 7

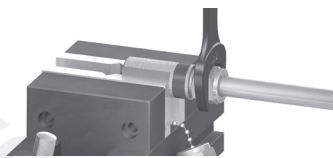
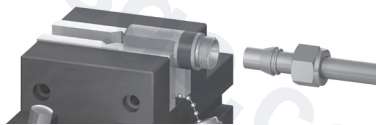

Fig. 8



1. Install the Swagelok nut and ferrules onto the preswaging tool (Fig. 5).
2. Insert the tube into the preswaging tool until it rests firmly on the shoulder of the tool; rotate the nut finger-tight (Fig. 6).
3. While holding the preswaging tool steady, tighten the nut with a wrench until it stops against the collar (Fig. 7).
4. Loosen the nut and remove the tube with preswaged ferrules from the preswaging tool. If the tube sticks, gently rock it back and forth. Do not turn the tube (Fig. 8).

Installation Instructions

Gaugeable Preswaging Tool, Tube Fitting Installation

Fig. 1

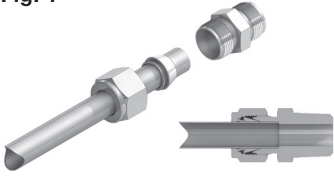

Fig. 2

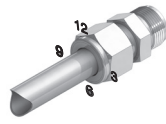
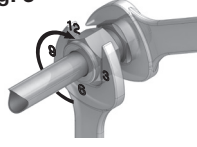

Fig. 3



1. Insert the tube with preswaged ferrules into the fitting until the front ferrule seats against the fitting body; rotate the nut finger-tight (Fig. 1).
2. Mark the nut at the 6 o'clock position (Fig. 2).
3. While holding the fitting body steady, tighten the nut one-half turn to the 12 o'clock position (Fig. 3).

Note: If assembling fittings for high-pressure applications or high safety-factor systems (severe service), tighten one hex flat further than one-half turn.

Gaugeability

Fig. 4

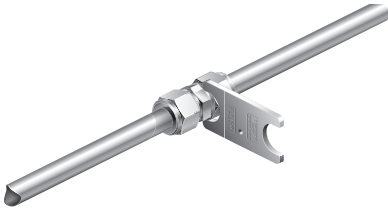
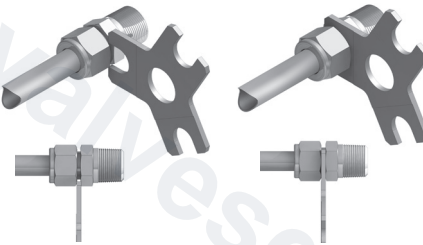

Fig. 5



On initial installation, the Swagelok gap inspection gauge assures the installer or inspector that a fitting has been sufficiently tightened.

If the nut was tightened additionally during installation (step 3), use Fig. 4 for gauging, otherwise use Fig. 5.

Position the Swagelok gap inspection gauge next to the gap between the nut and body.

- If the gauge will not enter the gap, the fitting is sufficiently tightened.
- If the gauge will enter the gap, additional tightening is required.



Tubing Tools and Accessories

For tube benders, tube preparation tools, and tube support systems, refer to *Tubing Tools and Accessories* catalog, [MS-01-179](#).

Leak Detectors, Lubricants, and Sealants

For liquid leak detectors, lubricants, and sealants, refer to *Leak Detectors, Lubricants, and Sealants* catalog, [MS-01-91](#).



Tubing Products

Swagelok offers a wide variety of tubing products.

Contact your authorized Swagelok representative or see these Swagelok catalogs for more information:



- *Stainless Steel Seamless Tubing, Fractional, Metric, and Imperial Sizes* catalog, [MS-01-181](#)
- *Ultrapure and High-Purity Stainless Steel Tubing, Fractional, Metric, and Imperial Sizes* catalog, [MS-01-182](#)

valvesgo.com

Safe Product Selection

When selecting a product, the total system design must be considered to ensure safe, trouble-free performance. Function, material compatibility, adequate ratings, proper installation, operation, and maintenance are the responsibilities of the system designer and user.

⚠ WARNING

Do not mix/interchange Swagelok products or components not governed by industrial design standards, including Swagelok tube fitting end connections, with those of other manufacturers.

Warranty Information

Swagelok products are backed by The Swagelok Limited Lifetime Warranty. For a copy, visit [swagelok.com](#) or contact your authorized Swagelok representative.

Swagelok, VCR, VCO, Snoop, Goop, SWAK, Ferrule-Pak—TM Swagelok Company
Krytox—TM DuPont
© 2006–2026 Swagelok Company
MS-01-140, RevAJ, February 2026